

Instruction Manual LNR110 Series



Instruction Manual LNR110 Series

Thank you for purchasing this product. Lorex is committed to providing our customers with a high quality, reliable security solution.

This manual refers to the following models:

LNR118 (8-channel)

For the latest online manual, downloads and product updates, and to learn about our complete line of accessory products, please visit our website at:

www.lorextechnology.com



WARNING

**RISK OF ELECTRIC SHOCK
DO NOT OPEN**



WARNING: TO REDUCE THE RISK OF ELECTRIC SHOCK DO NOT REMOVE COVER. NO USER SERVICABLE PARTS INSIDE.

REFER SERVICING TO QUALIFIED SERVICE PERSONNEL.



The lightning flash with arrowhead symbol, within an equilateral triangle, is intended to alert the user to the presence of uninsulated "dangerous voltage" within the product's enclosure that may be of sufficient magnitude to constitute a risk of electric shock.



The exclamation point within an equilateral triangle is intended to alert the user to the presence of important operating and maintenance (servicing) instructions in the literature accompanying the appliance.

WARNING: TO PREVENT FIRE OR SHOCK HAZARD, DO NOT EXPOSE THIS UNIT TO RAIN OR MOISTURE.

CAUTION: TO PREVENT ELECTRIC SHOCK, MATCH WIDE BLADE OF THE PLUG TO THE WIDE SLOT AND FULLY INSERT.

Table of contents

| | | |
|-----------|---|-----------|
| 1 | Important Safeguards | 1 |
| 1.1 | General Precautions | 1 |
| 1.2 | Installation | 1 |
| 1.3 | Service | 3 |
| 1.4 | Use | 3 |
| 2 | LNR110 Series Features | 4 |
| 3 | Getting Started (LNR110 Series) | 6 |
| 4 | Front Panel (LNR110 Series) | 7 |
| 5 | LNR110 Series Rear Panel | 8 |
| 6 | Basic Setup (LNR110 Series) | 9 |
| 6.1 | Step 1: Connect the IP Cameras | 9 |
| 6.2 | Step 2: Connect the Mouse | 9 |
| 6.3 | Step 3: Connect the Ethernet Cable | 10 |
| 6.4 | Step 4: Connect the Monitor | 10 |
| 6.5 | Step 5: Connect the Power Adapter to Power the NVR | 10 |
| 6.6 | Step 6: Upgrade Firmware to Latest Version (if Available) | 11 |
| 6.7 | Step 7: Verify Camera Image | 11 |
| 6.8 | Step 8: Set the Time | 11 |
| 6.9 | Default System Password & Port Numbers | 11 |
| 6.9.1 | FLIR Cloud™ | 12 |
| 6.10 | Quick Access to System Information | 12 |
| 6.11 | Connecting Cameras to the Local Area Network (LAN) | 13 |
| 7 | Mouse Control | 16 |
| 8 | Using the System | 17 |
| 8.1 | On-Screen Display | 17 |
| 8.2 | Using the Quick Menu | 17 |
| 8.3 | Adjusting Camera Image Settings | 18 |
| 8.4 | Using the Navigation Bar | 20 |
| 8.5 | Using the Camera Toolbar | 20 |
| 8.5.1 | Using Quick Playback | 21 |
| 8.5.2 | Using Digital Zoom in Live Display | 21 |
| 8.5.3 | Using Real-time Backup | 21 |
| 8.6 | Using the Virtual Keyboard | 22 |
| 8.7 | Adjusting Camera Zoom & Focus | 22 |
| 8.8 | Setting The Time | 23 |
| 9 | Recording | 25 |
| 9.1 | Video Recording Types | 25 |
| 9.2 | Main Stream and Sub Stream | 25 |
| 9.3 | Setting up Scheduled or Manual Recording | 25 |
| 9.4 | Configuring Hard Drive Overwrite | 26 |
| 10 | Search (Playback) | 28 |
| 10.1 | Playing Back Video from the Hard Drive | 28 |
| 10.2 | Playback Controls | 29 |
| 10.3 | Playing Back from a USB Drive | 29 |
| 11 | Backup | 31 |
| 11.1 | Formatting the USB Thumb Drive | 31 |
| 11.2 | Backing up Video | 32 |
| 11.3 | Using Video Clip Backup | 33 |
| 11.4 | Viewing Backup Files | 34 |

Table of contents

| | | | |
|-----------|---------|--|-----------|
| | 11.4.1 | Viewing Backup Files on PC | 34 |
| | 11.4.2 | Viewing Backup Files on Mac | 37 |
| 12 | | Managing Passwords and User Accounts..... | 40 |
| | 12.1 | Changing Passwords..... | 40 |
| | 12.2 | Adding Users | 41 |
| | 12.3 | Modifying Users | 41 |
| | 12.4 | Deleting Users | 42 |
| | 12.5 | Account Groups | 42 |
| | 12.6 | Adding Groups | 42 |
| | 12.7 | Modifying Groups | 43 |
| | 12.8 | Deleting Groups | 43 |
| 13 | | Using the Main Menu | 44 |
| | 13.1 | Camera | 44 |
| | 13.1.1 | Remote Device | 44 |
| | 13.1.2 | Viewing Camera Status | 45 |
| | 13.1.3 | Viewing Camera Firmware Versions | 45 |
| | 13.1.4 | Upgrading Camera Firmware | 45 |
| | 13.1.5 | Recording..... | 46 |
| | 13.1.6 | Configuring Recording Quality | 46 |
| | 13.1.7 | Configuring Snapshot Recording Settings..... | 47 |
| | 13.1.8 | Creating Custom Channel Names..... | 48 |
| | 13.2 | Info..... | 50 |
| | 13.2.1 | HDD Info | 50 |
| | 13.2.2 | Record Info..... | 50 |
| | 13.2.3 | Version | 51 |
| | 13.2.4 | Event Info | 51 |
| | 13.2.5 | Online Users | 52 |
| | 13.2.6 | Load..... | 52 |
| | 13.2.7 | Test..... | 53 |
| | 13.2.8 | BPS | 53 |
| | 13.2.9 | Log | 53 |
| | 13.3 | Setting..... | 54 |
| | 13.3.1 | Network | 54 |
| | 13.3.2 | Selecting DHCP or Static IP Address (TCP/IP) | 54 |
| | 13.3.3 | Configuring System Ports (Connection)..... | 55 |
| | 13.3.4 | Configuring DDNS Settings | 56 |
| | 13.3.5 | Configuring Email Alerts | 56 |
| | 13.3.6 | Configuring Switch Settings (Advanced)..... | 59 |
| | 13.3.7 | Event..... | 59 |
| | 13.3.8 | Configuring Motion Detection..... | 59 |
| | 13.3.9 | Configuring Video Loss Settings..... | 61 |
| | 13.3.10 | Configuring Hard Drive Warnings..... | 62 |
| | 13.3.11 | Configuring Network Warnings..... | 63 |
| | 13.3.12 | Storage..... | 63 |
| | 13.3.13 | Configuring the Video Recording Schedule | 64 |
| | 13.3.14 | Configuring Pre-Recording | 64 |
| | 13.3.15 | Configuring the Snapshot Schedule | 65 |
| | 13.3.16 | Configuring Holidays..... | 66 |
| | 13.3.17 | Formatting the Hard Drive | 67 |
| | 13.3.18 | Configuring Hard Drive Type | 68 |

Table of contents

| | | |
|-----------|--|------------|
| | 13.3.19 Configuring General System Settings | 68 |
| | 13.3.20 Setting the Monitor Resolution (Display) | 69 |
| | 13.3.21 Saving Your System Configuration to a USB Thumb Drive | 70 |
| | 13.3.22 Setting the System to Factory Defaults | 71 |
| | 13.3.23 Upgrading Firmware from USB | 72 |
| 13.4 | Shutdown..... | 73 |
| 14 | Connecting to Your System Over the Internet on PC or Mac | 74 |
| 14.1 | System Requirements..... | 74 |
| 14.2 | Step 1 of 3: Connect your System to Your Router | 74 |
| 14.3 | Step 2 of 3: Obtain the system's Device ID..... | 75 |
| 14.4 | Step 3 of 3: Connect to the System Over the Internet | 75 |
| 15 | Using FLIR Cloud™ Client for PC or Mac | 79 |
| 15.1 | Home Page | 79 |
| 15.2 | Live View | 79 |
| | 15.2.1 Live View Controls..... | 80 |
| | 15.2.2 Opening Live View in Multiple Monitors | 81 |
| 15.3 | Controlling PTZ Cameras | 82 |
| | 15.3.1 PTZ Presets..... | 83 |
| | 15.3.2 PTZ Tours..... | 84 |
| | 15.3.3 PTZ Pattern | 85 |
| | 15.3.4 PTZ Scan | 86 |
| | 15.3.5 PTZ Pan..... | 86 |
| 15.4 | Playback..... | 86 |
| 15.5 | Playback Controls..... | 88 |
| 15.6 | Downloading Video to your Computer Hard Drive..... | 89 |
| 15.7 | Alarm | 90 |
| 15.8 | Log..... | 91 |
| 15.9 | E-map | 92 |
| 15.10 | Devices | 94 |
| 15.11 | Device Config | 95 |
| 15.12 | Alarm CFG | 95 |
| 15.13 | Tour & Task | 98 |
| 15.14 | Account..... | 99 |
| | 15.14.1 Managing User Accounts | 99 |
| | 15.14.2 Managing Roles..... | 101 |
| 15.15 | General | 102 |
| | 15.15.1 Basic..... | 102 |
| | 15.15.2 File | 102 |
| | 15.15.3 Alarm Prompt | 103 |
| | 15.15.4 Version | 104 |
| 16 | Connecting to your System Using Smartphone or Tablet Apps..... | 105 |
| 16.1 | iPhone..... | 105 |
| | 16.1.1 Prerequisites | 105 |
| | 16.1.2 Connecting to your System on iPhone..... | 105 |
| | 16.1.3 Live View Interface | 106 |
| | 16.1.4 Controlling PTZ Cameras..... | 107 |
| | 16.1.5 Viewing Snapshots and Videos with Local Files | 108 |
| | 16.1.6 Using Playback Mode on iPhone | 109 |
| | 16.1.7 Enabling Push Notifications | 110 |

Table of contents

| | | |
|-----------|--|------------|
| | 16.1.8 Using the Event List | 112 |
| | 16.1.9 Using Favorites | 113 |
| | 16.1.10 Using the E-Map | 114 |
| | 16.1.11 Device Manager | 116 |
| | 16.1.12 Adding Devices Using an IP or DDNS Address (Advanced) | 117 |
| 16.2 | iPad | 119 |
| | 16.2.1 Prerequisites | 119 |
| | 16.2.2 Connecting to your system on an iPad | 119 |
| | 16.2.3 Live View Interface | 120 |
| | 16.2.4 Controlling PTZ Cameras | 121 |
| | 16.2.5 Using Playback Mode on iPad | 122 |
| | 16.2.6 Using Local File to View Manual Recordings | 124 |
| | 16.2.7 Enabling Push Notifications | 125 |
| | 16.2.8 Using the Event List | 127 |
| | 16.2.9 Using Favorites | 128 |
| | 16.2.10 Using the E-Map | 129 |
| | 16.2.11 Using the Device Manager | 131 |
| | 16.2.12 Adding Devices Using an IP or DDNS Address (Advanced) | 131 |
| 16.3 | Android | 134 |
| | 16.3.1 Prerequisites | 134 |
| | 16.3.2 Connecting to your System on Android | 134 |
| | 16.3.3 Live View Interface | 135 |
| | 16.3.4 Controlling PTZ Cameras | 136 |
| | 16.3.5 Viewing Snapshots and Videos with Local Files | 137 |
| | 16.3.6 Using Playback Mode on Android | 137 |
| | 16.3.7 Enabling Push Notifications | 139 |
| | 16.3.8 Using the Event List | 140 |
| | 16.3.9 Using Favorites | 140 |
| | 16.3.10 Using the E-Map | 142 |
| | 16.3.11 Device Manager | 143 |
| | 16.3.12 Adding Devices Using an IP or DDNS Address (Advanced) | 144 |
| 17 | DDNS Setup (Advanced) | 146 |
| | 17.1 Accessing your System within a Local Network (LAN) | 146 |
| | 17.1.1 Step 1 of 3: Connect your System to Your Router | 146 |
| | 17.1.2 Step 2 of 3: Obtain the System's Local IP Address | 147 |
| | 17.1.3 Step 3 of 3: Connect to the System's Local IP Address | 147 |
| | 17.2 DDNS Setup—Access your System Remotely over the Internet | 149 |
| | 17.2.1 Step 1 of 4: Port Forwarding | 150 |
| | 17.2.2 Step 2 of 4: Create a DDNS Account | 150 |
| | 17.2.3 Step 3 of 4: Enable DDNS on the System | 154 |
| | 17.2.4 Step 4 of 4: Connect to the System's DDNS Address | 154 |
| 18 | Connecting a PTZ Camera (LNR110 Series) | 158 |
| | 18.1 Controlling a PTZ Camera (Local NVR) | 158 |
| | 18.2 Advanced PTZ Controls | 158 |
| | 18.2.1 Presets | 159 |
| | 18.2.2 Tours | 160 |

Table of contents

| | | |
|-----------|--|------------|
| | 18.2.3 Pattern..... | 160 |
| | 18.2.4 Auto Scan | 161 |
| 19 | LNR110 Series Hard Drive Installation..... | 162 |
| | 19.1 Installing a Hard Drive..... | 162 |
| | 19.2 Removing the Hard Drive..... | 164 |
| | 19.3 Formatting Hard Drives | 166 |
| 20 | Recording Audio | 167 |
| | 20.1 Step 1 of 2: Connecting an audio-capable camera | 167 |
| | 20.2 Step 2 of 2: Configuring audio recording | 168 |
| 21 | LNR110 Series Troubleshooting | 169 |
| 22 | LNR110 Series System Specifications..... | 171 |
| | 22.1 System | 171 |
| | 22.2 Inputs/Outputs | 171 |
| | 22.3 Display | 171 |
| | 22.4 Recording | 171 |
| | 22.5 Playback and Backup | 172 |
| | 22.6 Storage & Archive | 172 |
| | 22.7 Connectivity..... | 172 |
| | 22.8 General | 172 |
| | 22.9 Recording Resolution (Pixels) & Speed (FPS — Frames per second) | 173 |
| 23 | Notices..... | 174 |
| | 23.1 FCC/IC Notice..... | 174 |
| | 23.2 Modification..... | 174 |
| | 23.3 ROHS | 174 |

Important Safeguards

In addition to the careful attention devoted to quality standards in the manufacturing process of your product, safety is a major factor in the design of every instrument. However, safety is your responsibility too. This sheet lists important information that will help to ensure your enjoyment and proper use of the product and accessory equipment. Please read them carefully before operating and using your product.

1.1 General Precautions

1. All warnings and instructions in this manual should be followed.
2. Remove the plug from the outlet before cleaning. Do not use liquid aerosol detergents. Use a water-dampened cloth for cleaning.
3. Do not use this product in humid or wet places.
4. Keep enough space around the product for ventilation. Slots and openings in the storage cabinet should not be blocked.
5. It is highly recommended to connect the product to a surge protector to protect from damage caused by electrical surges. It is also recommended to connect the product to an uninterruptible power supply (UPS), which has an internal battery that will keep the product running in the event of a power outage.

CAUTION

Maintain electrical safety. Power line operated equipment or accessories connected to this product should bear the UL listing mark or CSA certification mark on the accessory itself and should not be modified so as to defeat the safety features. This will help avoid any potential hazard from electrical shock or fire. If in doubt, contact qualified service personnel.

1.2 Installation

1. **Read and Follow Instructions** - All the safety and operating instructions should be read before the product is operated. Follow all operating instructions.
2. **Retain Instructions** - The safety and operating instructions should be retained for future reference.
3. **Heed Warnings** - Comply with all warnings on the product and in the operating instructions.
4. **Polarization** - Do not defeat the safety purpose of the polarized or grounding-type plug.
A polarized plug has two blades with one wider than the other.



A grounding type plug has two blades and a third grounding prong.



The wide blade or the third prong are provided for your safety.

If the provided plug does not fit into your outlet, consult an electrician for replacement of the obsolete outlet.

5. **Power Sources** - This product should be operated only from the type of power source indicated on the marking label. If you are not sure of the type of power supplied to your location, consult your video dealer or local power company. For products intended to operate from battery power, or other sources, refer to the operating instructions.
6. **Overloading** - Do not overload wall outlets or extension cords as this can result in the risk of fire or electric shock. Overloaded AC outlets, extension cords, frayed power cords, damaged or cracked wire insulation, and broken plugs are dangerous. They may result in a shock or fire hazard. Periodically examine the cord, and if its appearance indicates damage or deteriorated insulation, have it replaced by your service technician.
7. **Power-Cord Protection** - Power supply cords should be routed so that they are not likely to be walked on or pinched by items placed upon or against them. Pay particular attention to cords at plugs, convenience receptacles, and the point where they exit from the product.
8. **Surge Protectors** - It is highly recommended that the product be connected to a surge protector. Doing so will protect the product from damage caused by power surges. Surge protectors should bear the UL listing mark or CSA certification mark.
9. **Uninterruptible Power Supplies (UPS)** - Because this product is designed for continuous, 24/7 operation, it is recommended that you connect the product to an uninterruptible power supply. An uninterruptible power supply has an internal battery that will keep the product running in the event of a power outage. Uninterruptible power supplies should bear the UL listing mark or CSA certification mark.
10. **Ventilation** - Slots and openings in the case are provided for ventilation to ensure reliable operation of the product and to protect it from overheating. These openings must not be blocked or covered. The openings should never be blocked by placing the product on a bed, sofa, rug, or other similar surface. This product should never be placed near or over a radiator or heat register. This product should not be placed in a built-in installation such as a bookcase or rack unless proper ventilation is provided and the product manufacturer's instructions have been followed.
11. **Attachments** - Do not use attachments unless recommended by the product manufacturer as they may cause a hazard.
12. **Water and Moisture** - Do not use this product near water — for example, near a bath tub, wash bowl, kitchen sink or laundry tub, in a wet basement, near a swimming pool and the like.
13. **Heat** - The product should be situated away from heat sources such as radiators, heat registers, stoves, or other products (including amplifiers) that produce heat.
14. **Accessories** - Do not place this product on an unstable cart, stand, tripod, or table. The product may fall, causing serious damage to the product. Use this product only with a cart, stand, tripod, bracket, or table recommended by the manufacturer or sold with the product. Any mounting of the product should follow the manufacturer's instructions and use a mounting accessory recommended by the manufacturer.



15. **Camera Extension Cables** – Check the rating of your extension cable(s) to verify compliance with your local authority regulations prior to installation.
16. **Mounting** - The cameras provided with this system should be mounted only as instructed in this guide or the instructions that came with your cameras, using the provided mounting brackets.

17. **Camera Installation** - Cameras are not intended for submersion in water. Not all cameras can be installed outdoors. Check your camera environmental rating to confirm if they can be installed outdoors. When installing cameras outdoors, installation in a sheltered area is required.

1.3 Service

1. **Servicing** - Do not attempt to service this product yourself, as opening or removing covers may expose you to dangerous voltage or other hazards. Refer all servicing to qualified service personnel.
2. **Conditions Requiring Service** - Unplug this product from the wall outlet and refer servicing to qualified service personnel under the following conditions:
 - When the power supply cord or plug is damaged.
 - If liquid has been spilled or objects have fallen into the product.
 - If the product has been exposed to rain or water.
 - If the product has been dropped or the cabinet has been damaged
 - If the product does not operate normally by following the operating instructions. Adjust only those controls that are covered by the operating instructions. Improper adjustment of other controls may result in damage and will often require extensive work by a qualified technician to restore the product to its normal operation.
 - When the product exhibits a distinct change in performance. This indicates a need for service.
3. **Replacement Parts** - When replacement parts are required, have the service technician verify that the replacements used have the same safety characteristics as the original parts. Use of replacements specified by the product manufacturer can prevent fire, electric shock, or other hazards.
4. **Safety Check** - Upon completion of any service or repairs to this product, ask the service technician to perform safety checks recommended by the manufacturer to determine that the product is in safe operating condition.

1.4 Use

1. **Cleaning** - Unplug the product from the wall outlet before cleaning. Do not use liquid cleaners or aerosol cleaners. Use a damp cloth for cleaning.
2. **Product and Cart Combination** - When product is installed on a cart, product and cart combination should be moved with care. Quick stops, excessive force, and uneven surfaces may cause the product and cart combination to overturn.
3. **Object and Liquid Entry** - Never push objects of any kind into this product through openings as they may touch dangerous voltage points or "short-out" parts that could result in a fire or electric shock. Never spill liquid of any kind on the product.
4. **Lightning** - For added protection of this product during a lightning storm, or when it is left unattended and unused for long periods of time, unplug it from the wall outlet and disconnect the antenna or cable system. This will prevent damage to the product due to lightning and power line surges.



Features

- Full high definition 1080p recording.
- Real-time recording at 30fps per channel.
- 8 Built in PoE (Power Over Ethernet) ports providing video and power on a single Ethernet cable.
- Automatically detects compatible IP cameras in the network.¹
- 24/7 security-grade hard drive.²
- H.264 video compression.²
- Expandable High Capacity Storage up to 4TB.
- Pentaplex operation - view, record, playback, backup & remotely control the system simultaneously.
- Simultaneous playback and live view on the same screen.³
- Selectable area digital zoom in live view and playback.
- Dynamic click-and-drag camera channel assignment.
- Convenient front panel button controls.
- Accurate time stamps with NTP & daylight savings time.
- Instant USB backup of live video from selected camera.
- 2 video outputs (HDMI & VGA) to connect multiple monitors.
- HDMI cable included for simple connection to HDTVs.
- Keep up to date with automatic firmware upgrades.⁴
- 3-Step remote view with FLIR Cloud™.⁵
- PC and Mac compatible.⁶
- Free iOS and Android compatible apps with live viewing, playback, video recording, and snap shot.⁶
- Dedicated iPad app with multi-channel live viewing and playback.
- Push notifications of motion events.
- Instant email alerts with snap shot attachment.
- Dual streaming to conserve bandwidth.
- Continuous, scheduled and motion recording.

**NOTE**

1. Compatible with select Lorex 1080p wired PoE HD cameras only. For a list of compatible cameras, please visit www.lorextechnology.com/support
2. Recording time may vary based on recording resolution & quality, lighting conditions and movement in the scene.
3. Instant playback feature available on one camera at a time during live view when in quad or multiple camera viewing mode.
4. The NVR firmware and software must be upgraded to the latest version to use the FLIR Cloud™ service. When the system is connected to the Internet, it will automatically alert you if there is a firmware upgrade available.
5. Requires a high speed internet connection and a router (not included). A minimum upload speed of 1Mbps is required for the best video performance. Up to 3 devices may connect to the system at the same time.
6. For the latest list of supported apps and devices, please visit www.lorextechnology.com/support

Use product in accordance with the instructions provided. All trademarks belong to their respective owners. No claim is made to the exclusive right to use the trademarks listed, other than the trademarks owned by Lorex Corporation. We reserve the right to change models, configurations or specifications without notice or liability. Product may not be exactly as shown. Images are simulated.

Getting Started (LNR110 Series)

The system comes with the following components:

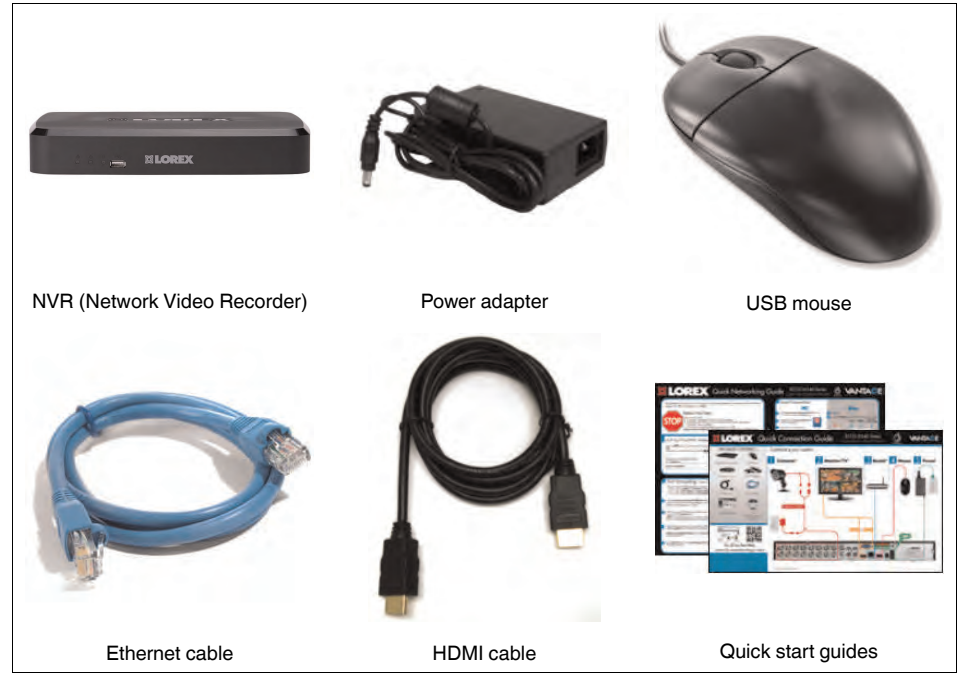

Hard drive size, number of channels, and camera configuration may vary by model. Please refer to your package for specific details. Check your package to confirm that you have received the complete system, including all components shown above.

Front Panel (LNR110 Series)



1. **NET:** Glows when network is in normal state. Turns off for network error.
2. **Power Indicator:** Glows to indicate the system is on.
3. **HDD:** Glows to indicate hard drive is in normal state. Turns off when there is a hard drive error.
4. **USB Port:** Connect a USB mouse (included) or connect a USB flash drive (not included) for data backup or firmware upgrades.

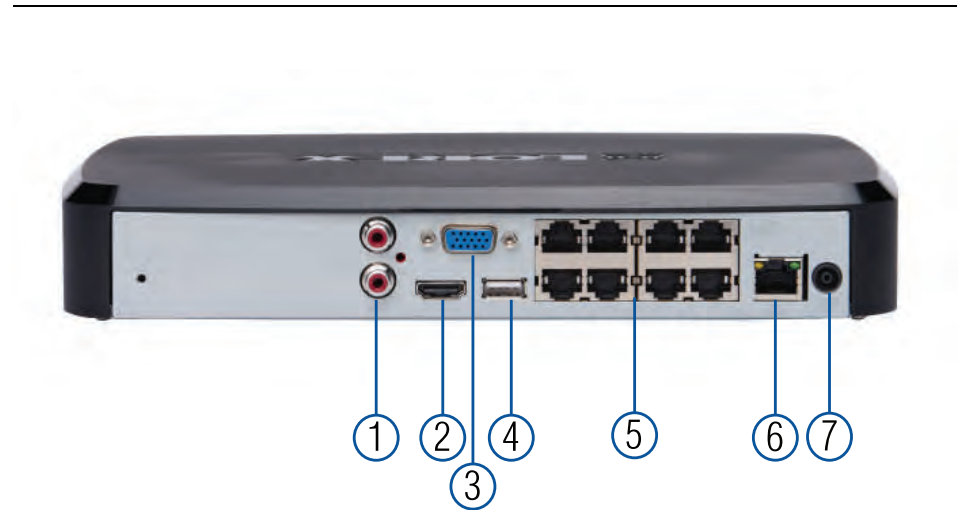

1. **MIC IN/OUT:** Service only; not supported.

**NOTE**

Audio-enabled IP cameras (not included) are required to use audio recording. You cannot record audio from the input (e.g. microphone) connected to the MIC IN port.

2. **HDMI:** Connect to an HDMI monitor or TV (not included) to view the system interface.
3. **VGA:** Connect a VGA monitor (not included) to view the system interface.
4. **USB port:** Connect a USB mouse (included) or USB thumb drive (not included) for data backup or firmware updates.
5. **PoE Ports:** Connect IP cameras. Integrated PoE (Power Over Ethernet) ports provide power to cameras and video connection to NVR.
6. **LAN:** Connect a CAT 5 RJ45 Ethernet cable for local and remote connectivity.
7. **Power input:** Connect the included power adapter.

6.1 Step 1: Connect the IP Cameras

Option 1: Direct Connection to NVR

- Connect cameras to the **PoE Ports** on the rear panel of the NVR using Cat5e or higher grade Ethernet cable. The cameras will appear on the NVR without any additional configuration when the system starts up.



NOTE

Compatible with select Lorex 1080p wired PoE HD cameras only. For a list of compatible cameras, please visit www.lorexttechnology.com/support



Connect IP cameras directly to PoE ports.

Option 2: Connect Cameras to Local Network

You can also connect your IP cameras to your local network for flexible installations. You will need to do this to connect cameras 9~16 to 16-channel models. For details, see 6.11 *Connecting Cameras to the Local Area Network (LAN)*, page 13.

6.2 Step 2: Connect the Mouse

- Connect a USB mouse (included) to one of the **USB** ports.



6.3 Step 3: Connect the Ethernet Cable

- Connect an Ethernet cable (included) to the **LAN** port on the rear panel of the system. Connect the other end of the Ethernet cable to a router on your network.



6.4 Step 4: Connect the Monitor

- Connect the included HDMI cable from the **HDMI** port to the TV or monitor (recommended).
- OR**
- Connect a VGA cable (not included) from the **VGA** port to the monitor.

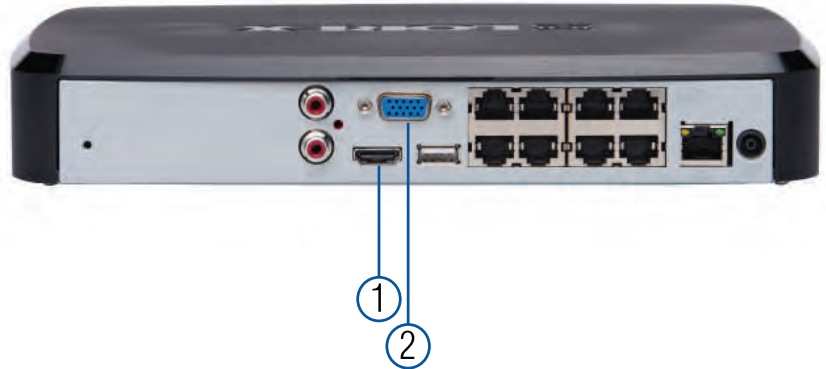

1. HDMI port.
2. VGA port.

6.5 Step 5: Connect the Power Adapter to Power the NVR

- Connect the included AC power adapter to the NVR and connect the other end to a power outlet or surge protector.



At startup, the system performs a basic system check and runs an initial loading sequence. After a few moments, the system loads a live display view.

6.6 Step 6: Upgrade Firmware to Latest Version (if Available)

If a firmware upgrade is available, you will be asked to install it once the system starts up. It is required to upgrade your system firmware and client software or mobile apps to the latest version to enable remote connection to the system.

If a firmware upgrade is available:

1. After startup, a notification will appear asking you to upgrade the firmware. Click **OK** to upgrade.
2. Enter the system user name (default: **admin**) and password (default: **000000**) and click **OK**. Wait for the firmware update to complete. The system will restart once the firmware has been upgraded.



WARNING

DO NOT POWER OFF THE SYSTEM OR DISCONNECT THE POWER CABLE DURING FIRMWARE INSTALLATION

6.7 Step 7: Verify Camera Image

- Power on the cameras, and then verify the camera video quality before mounting the cameras to a permanent location.
- Mount the cameras under a sheltered location. Always verify the outdoor rating of your camera before installing it in a permanent location.

6.8 Step 8: Set the Time

- Set the system time and date for accurate video time stamps. Videos with inaccurate times may not be valid as surveillance evidence.
- For details on setting the system time, see 8.8 *Setting The Time*, page 23.

6.9 Default System Password & Port Numbers



CAUTION

By default, the system user name is **admin** and the password is **000000**. It is essential that you create your own password. For details, see 12 *Managing Passwords and User Accounts*, page 40.

The system requires a user name and password to log in to the system remotely using a computer or mobile device. After logging on remotely the first time, you will be asked to create a custom password for the system.

Local system and remote connectivity (LAN & Internet) user name and password:

- Username: **admin**
- Password: **000000**

Default ports for DDNS remote access:

- Port **80** (HTTP port)
- Port **35000** (Client port)

6.9.1 FLIR Cloud™

This system features the exclusive FLIR Cloud™. This is a cloud service that allows you to connect to your system over the Internet via a secure handshake with our servers. This means you can easily connect to your system without requiring any network configuration.

For details on setting up your system to connect to the Internet using FLIR Cloud™:

- See 14 *Connecting to Your System Over the Internet on PC or Mac*, page 74.
- OR**
- See 16 *Connecting to your System Using Smartphone or Tablet Apps*, page 105.

Connectivity using Lorex's free DDNS service is also available, but requires the ports listed above to be port forwarded on your router.

6.10 Quick Access to System Information

To quickly open a window that displays vital system information:

- Right-click to open the Quick Menu and click **Info**. Enter the system user name (default: **admin**) and password (default: **000000**).



NOTE

The QR code shown in the System Info screen can be scanned during mobile setup to enter the system's Device ID.

6.11 Connecting Cameras to the Local Area Network (LAN)

For flexibility, you may also connect IP cameras to the same Local Area Network (LAN) as the NVR. This is accomplished by connecting the cameras to the same router as the NVR.

For these installations, an external PoE switch (sold separately) or power adapter (sold separately) must be used to provide power to each IP camera. You also must add the cameras on the NVR before they will show a picture on the monitor or be recorded by the NVR.

Follow the steps below to connect the cameras to the NVR over the LAN.

NOTE

- Compatible with Lorex 1080p wired PoE HD cameras only. For a list of compatible cameras, please visit www.lorextechnology.com/support.
- Camera and NVR images in this section are used for illustration only.

Step 1 of 2 — Option A: Connecting cameras to your local network using a PoE switch:

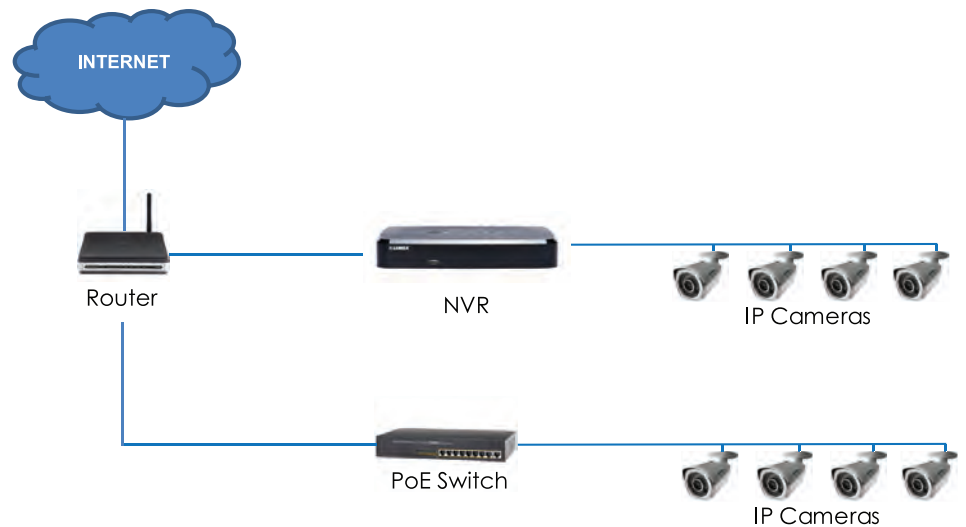

1. Connect an Ethernet cable from the LAN port on an external PoE switch (sold separately on www.lorextechnology.com) to your router using a CAT5e or higher Ethernet cable. Connect the power cable to the PoE switch and to a power outlet or surge protector.

NOTE

Terminology may vary depending on the model of PoE switch you have.

2. Connect the IP cameras to the PoE switch using the Ethernet extension cables. The PoE switch will provide power and video transmission the same way as your NVR.

Step 1 of 2 — Option B: Connecting cameras to your local network using power adapters:

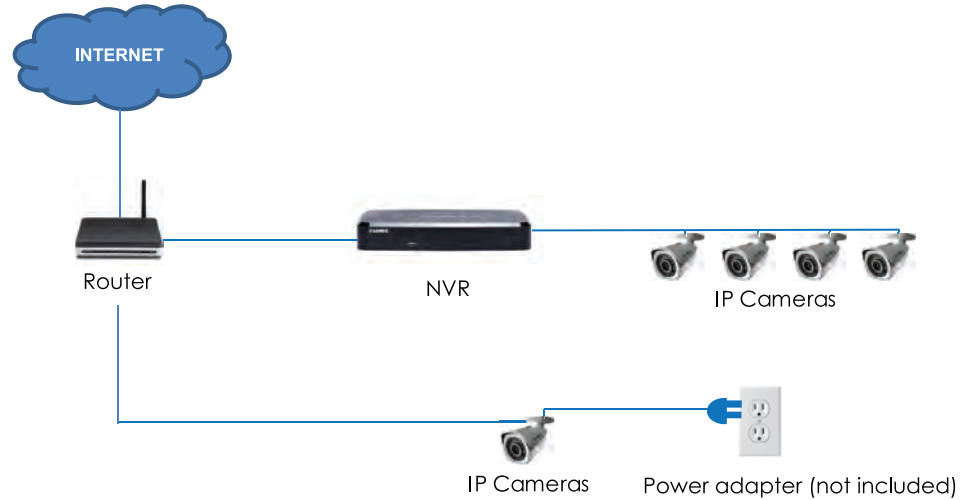

1. Connect each camera to a compatible power adapter (visit www.lorextechnology.com for compatible power adapters for your cameras).
2. Connect the camera to your router using a CAT5e or higher Ethernet cable.

Step 2 of 2: Add the cameras to your NVR:

1. Right-click and select **Device Search**.
2. Log in using the admin account (default User Name: **admin**; default Password: **000000**).
3. Click **Device Search**. The system searches the network for compatible cameras.

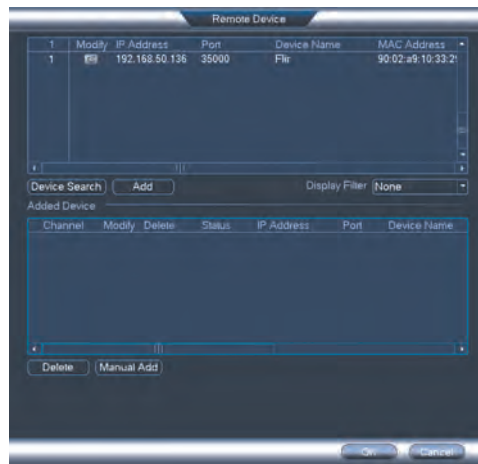

4. Check the camera(s) you would like to add.

- Click **Add**. The Status indicator turns green to show the camera is successfully connected.

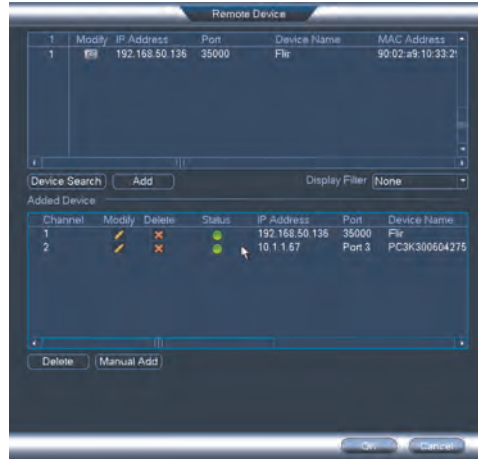

- Click **OK** to save changes.

**NOTE**

You can also add a camera to a specific channel by hovering the mouse over an empty channel in split-screen view and clicking . Then double-click the camera you would like to add and right click to exit.

The mouse is the primary control device for the system. To connect a USB mouse:

- Connect a USB mouse to the USB port on the front or rear panel.

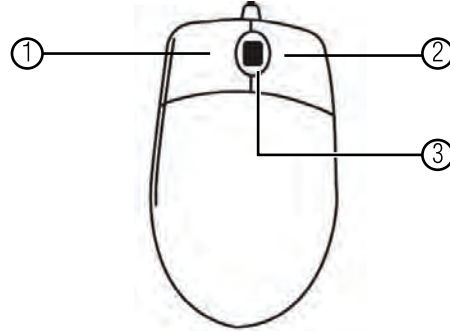

1. Left-button:

- In live view, click to open the Navigation Bar. Right-click to close the navigation bar.
- In live view, while in a split-screen display mode, double-click an individual channel to view it in full-screen. Double-click again to return to the split-screen display mode.
- While navigating menus, click to open a menu option.

2. Right-button:

- During live view, right-click anywhere on the screen to open the Quick Menu.
- Within system menus, right-click to exit menus.

3. Scroll wheel: In live view, use the scroll wheel to zoom in/out.

Use the system's graphical on-screen display to navigate menus and configure options and settings.

8.1 On-Screen Display

The system shows the following for all display views:



1. Display area:

- Double-click on a channel to view in full-screen; double-click again to return to split screen.
- Right-click to open the Quick Menu.
- Left-click to open the Navigation Bar.
- Move the mouse to the top of a channel to view the Camera Toolbar.
- Click-and-drag cameras to rearrange the channel display. This does not affect the channels each camera is connected or recording to.

2. Channel name

3. **C:** Camera is continuously recording.

4. **M:** Motion has been detected.



5. **Date & time:** Current system date and time. For details on setting the date and time, see 8.8 *Setting The Time*, page 23.

8.2 Using the Quick Menu

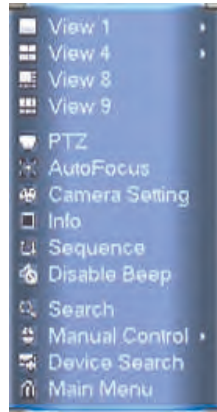
The Quick menu gives you access to the system's key functions. To access the Quick Menu, right-click the screen during live view.



The Quick Menu has the following options:

- **View:** Select a camera in full-screen or select a multi-channel display.
- **PTZ:** Access controls for PTZ cameras (not included).
- **AutoFocus:** Access zoom/focus controls for auto-focus cameras (not included).
- **Camera Setting:** Configure image settings for cameras.
- **Info:** Opens the system information window.
- **Sequence:** Click to start/stop sequence mode.
 In sequence mode, the system will automatically cycle through connected cameras every few seconds. A  will appear to show that sequence mode is on.
 Click the icon to pause sequence mode on the channel that is currently shown (icon changes to ). Click again to resume sequence mode.
 Right-click and select **Sequence** to return to normal viewing mode.
- **Disable Beep:** Turns off the beeping noise.
- **Search:** Search/playback recorded video. See 10 *Search (Playback)*, page 28.
- **Manual Control:** Click **Record** to open the Record menu to select manual recording options. See 9.3 *Setting up Scheduled or Manual Recording*, page 25.
- **Device Search:** Open the Device Search menu to manage IP cameras over the local network.
- **Main Menu:** Open the Main Menu. See 13 *Using the Main Menu*, page 44.

8.3 Adjusting Camera Image Settings

Use the Camera Setting menu to adjust image settings for your cameras.

To adjust image settings:

1. Right-click on the channel you would like to configure and select **Camera Setting**. Enter the system password if prompted.

2. Configure the following settings as needed:

**NOTE**

The settings listed below are only shown if they are supported on the selected camera. Some camera models do not support all settings.

- **Mirror:** Select **Enable** to flip the image horizontally.
- **Flip:** Select **Flip 180°** to flip the image vertically, or select **No Flip** for the default orientation.
- **Corridor Mode:** Not supported.
- **BLC Mode:** Select **High** or **Low** to enable back light compensation or **Off** to disable. Back light compensation adjusts the lighting levels in the picture so you can see objects in the foreground if there is a strong light source behind them.
- **Scene Mode:** The Scene Mode allows you to adjust white balance levels for the camera. Select **Schedule** for the camera to automatically adjust the white balance. Select **Sunny** or **Night** to use preset white balance levels. Select **Customized** to manually set blue and red levels.
- **Day&Night:** This setting sets the camera's day/night mode. Select **Colorful** for the camera to use color mode at all times. Select **Schedule** for the camera to automatically determine whether to use color or black and white mode. Select **Black&White** for the camera to use black and white mode at all times.

**NOTE**

It is recommended to select Schedule mode, as using Colorful may impact the camera's performance at night.

- **Saturation:** Adjust the vibrancy of colors in the image.
- **Brightness:** Adjust the image brightness.
- **Contrast:** Adjust the image contrast.
- **Hue:** Adjust the color hue of the image.

- Click **OK** to save changes.

| |
|--|
|  NOTE |
| <p>You must save changes to apply settings changes. It is recommended to adjust one setting at a time so you can see the results of each change. Click Default to reset the camera to default image settings.</p> |

8.4 Using the Navigation Bar

The Navigation Bar gives quick access to certain functions and menus.

To open the Navigation bar:

- Left click on the screen to open the Navigation Bar. The Navigation Bar has the following options:



- Main Menu.**
- Collapse.**
- Select display layout.**
- Sequence:** Click to start/stop sequence mode.
- PTZ:** Click to open PTZ controls.
- Camera Setting:** Click to open camera image settings.
- Search:** Search and playback recorded video. See 15.4 *Playback*, page 86.
- Event:** View events in progress. See 13.2.4 *Event Info*, page 51.
- Channel Info:** Click to access status information about connected cameras.
- Remote Device:** Manage IP cameras over the network.
- Network:** Configure network settings for your system. See 13.3.1 *Network*, page 54.
- HDD Manager:** Manage hard drives connected to the system. See 13.3.17 *Formatting the Hard Drive*, page 67.
- USB Manager:** Click to access options for connected USB thumb drives (not included). You can backup video, logs, or system configurations and install firmware upgrades.
- System Upgrade:** Check for firmware upgrades. The system must be connected to the Internet to check for or receive updates.

8.5 Using the Camera Toolbar

The Camera Toolbar is used to perform actions on a specific channel.

To access the Camera Toolbar:

- Move the mouse to the top of the channel display. The Camera Toolbar has the following options:

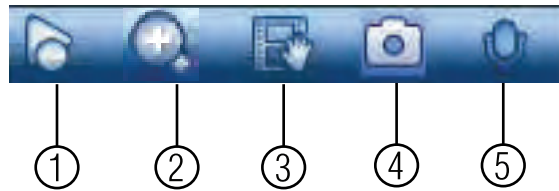

1. **Instant Playback.**
2. **Digital zoom.**
3. **Real-time backup.**
4. **Snapshot.**
5. **2-way audio.**

8.5.1 Using Quick Playback

Quick Playback is used to playback the last 5–60 minutes of video from the selected channel. You can also access Quick Playback in split-screen mode, while still viewing live video from the other channels.

To use Quick Playback:



1. Move your mouse to the top of the channel display and click .

NOTE

By default, the system will begin playback from 5 minutes ago. You can increase this to up to 60 minutes using the **Instant Playback** setting in **Main Menu>Setting>General**.

2. Right-click to exit Quick Playback.

8.5.2 Using Digital Zoom in Live Display

1. Move your mouse to the top of the channel display and click  to activate digital zoom. A check mark will appear in the icon to indicate digital zoom is activated ().

NOTE

You may activate digital zoom in multiple channels at the same time.



2. Click and drag inside the channel to zoom in.
 - Click and drag to pan the zoom area.
 - Right-click to zoom out and select a new zoom area.
 - Click  to disable digital zoom. Note that the channel will remain at the same zoom level until you right-click inside it.

8.5.3 Using Real-time Backup

Real-time backup allows you to save footage from the live display to a USB thumb drive (not included) or external hard drive (not included).

To use Real-time Backup:

1. Insert the USB thumb drive or external hard drive into one of the USB ports on the system.

2. Move your mouse to the top of the channel display and click  to start Real-time Backup.
3. Click  again to end Real-time Backup. The file is saved to your USB device.

**NOTE**

If the system prompts you to log in, you will need to click  again to start Real-time Backup after logging in.

8.6 Using the Virtual Keyboard

The Virtual Keyboard is used to input text or numeric values in certain menus.

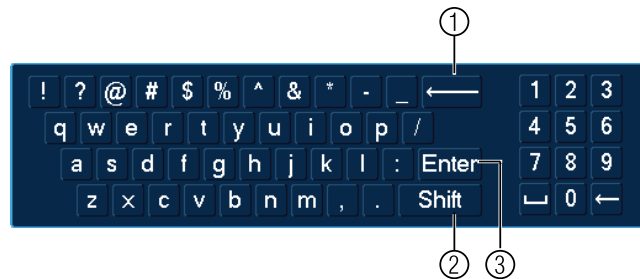

1. **Backspace.**
2. **Enter capital letters.**
3. **Confirm entry.**

8.7 Adjusting Camera Zoom & Focus

Auto-focus cameras (not included) have a motorized lens. The motorized lens allows you to control the zoom and focus settings using the menus on your system.

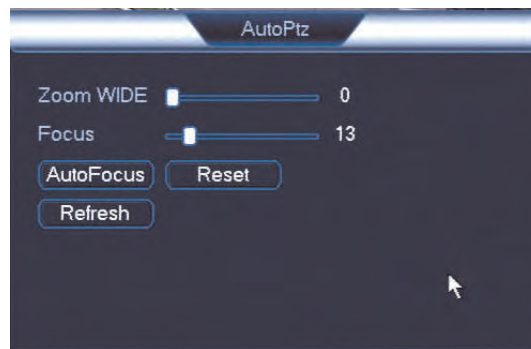
**To adjust the camera's zoom focus:**

1. Double-click on the channel where the motorized lens camera is connected.
2. Right-click and then click **AutoFocus**. Log into the system using the admin account (default user name is **admin** and password is **000000**).
3. Adjust the zoom and focus using the following options:
 - Use the sliders to adjust the **Zoom WIDE** or **Focus** settings for the camera.

 **NOTE**

Hover the mouse over the sliders and use the mouse wheel to adjust by 1% at a time.

- Click the **AutoFocus** button to automatically focus the camera at the current zoom level.
 - Click **Reset** to return the camera to the default zoom and focus levels.
 - Click **Refresh** to refresh the settings shown on the system if someone has used the manual lens controls on the camera.
4. Right-click to exit and save changes.

8.8 Setting The Time

 **CAUTION**

It is highly recommended to set the date and time when first setting up your system.

Inaccurate time stamps may render your footage unusable for court evidence.

To set the date and time:

1. In the main viewing mode, right-click and click **Main Menu**.
2. Log in using the system user name (default: **admin**) and password (default: **000000**).
3. Click  and select **Setting**. Click **General** and select the **Date&Time** tab.

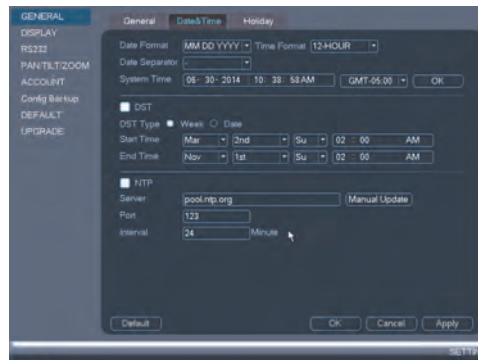

4. Under **System Time**, enter the current time and select your time zone. Then, click **OK**.
5. Check **DST** to enable auto Daylight Savings Time updates.

 **NOTE**

- You can adjust the **Start Time** and **End Time** for Daylight Savings Time if the default settings do not match your region.
- Under **DST Type**, select **Day of Week** to set the start and end time based on a day and week (e.g. 2nd Sunday in March), or select **Date** to set the start and end time to a specific date.

6. (Optional) Check **NTP** to sync your system with an Internet time server. Click **Manual Update** to instantly update the time.

 **NOTE**



- Your system must have a constant connection to the Internet to use NTP.
- (Advanced) You can enter a custom NTP server under **Server IP** and **Port**, and you can select how often the system will sync the time using **Interval**.

7. Click **Apply** to save changes.

By default, the system is set to immediately record video from connected cameras continuously, 24 hours a day. You can customize the recording settings according to your needs.

9.1 Video Recording Types

The system supports the following recording types.

- **Recording—Continuous:** Normal, continuous recording. A  icon is shown when recording is in progress.
- **Recording—Motion:** The system records when motion is detected by the camera. An  icon is shown when motion is detected.

9.2 Main Stream and Sub Stream

The system employs two video recording streams, a Main Stream and a Sub Stream. Both Main Stream and Sub Stream recording are enabled by default.

The Main Stream records high quality video to your system's hard drive.

The Sub Stream records lower resolution video for efficient streaming to devices over the Internet. Sub Stream recording must be enabled to view video recordings on a computer or mobile device.

You can configure the video quality parameters for the Main Stream or Sub Stream. For details, see 13.1.6 *Configuring Recording Quality*, page 46.

9.3 Setting up Scheduled or Manual Recording

You can set the system to record based on a schedule or you can manually turn recording on and off. By default, the system is set to record on an always on recording schedule.

To configure the recording schedule, see 13.3.13 *Configuring the Video Recording Schedule*, page 64.

To select between scheduled and manual recording:

1. Right-click and then select **Manual Control>Record**.

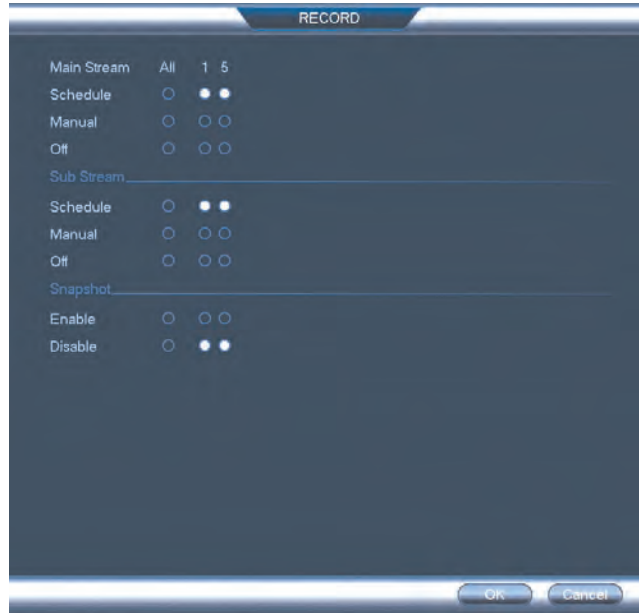

2. Under **Main Stream**, select how the system will record the Main Stream for each channel.
 - **Schedule:** Main Stream Recording will follow the recording schedule.
 - **Manual:** The system will record the Main Stream continuously as long as this option is checked.
 - **Stop:** The system will not record the Main Stream for this channel. This option is not recommended.
3. Under **Sub Stream**, select how the system will record the Sub Stream for each channel.
 - **Schedule:** Sub Stream Recording will follow the recording schedule.
 - **Manual:** The system will record the Sub Stream continuously as long as this option is checked.
 - **Stop:** The system will not record the Sub Stream for this channel.
4. Under **Snapshot**, select **Enable** to enable snapshot recording on each channel. Or, select **Disable** to disable snapshot recording.
5. Click **OK** to save changes.

9.4 Configuring Hard Drive Overwrite

When the hard drive is full, the system will overwrite the oldest recordings by default. This is recommended, as it makes sure that your system will continue to record without any input from you. You can also set the system to stop recording once the hard drive is full.

To configure hard drive overwrite:

1. Right-click and select **Main Menu**. Click  > **Setting>General>General**.

2. Under **HDD Full**, select **Overwrite** for the system to overwrite the oldest recordings when the hard drive is full. Or, select **Stop Record** for the system to stop recording when the hard drive is full.

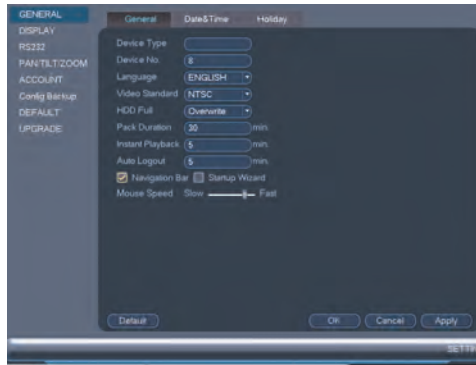

3. Click **OK** to save changes.

Search mode is used to navigate and playback recorded video files on the system.

10.1 Playing Back Video from the Hard Drive

1. From live view, right-click and then click **Search**.
2. Log in using the system user name (default: **admin**) and password (default: **000000**).
3. Configure the following:

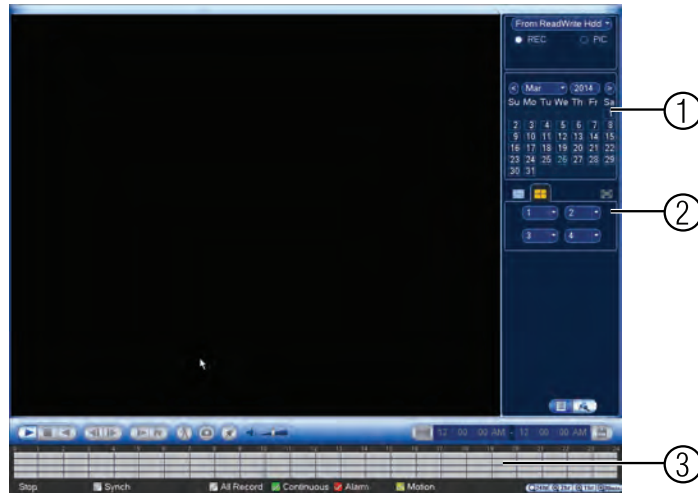

- 3.1. Use the calendar on the right to select the day to playback.
- 3.2. Use the drop-down menus to select the channels you would like to playback.

NOTE

Click the display options () to playback multiple channels simultaneously.

- 3.3. Click inside the video bar to select the playback time. The system will begin playing back at the selected time.

10.2 Playback Controls

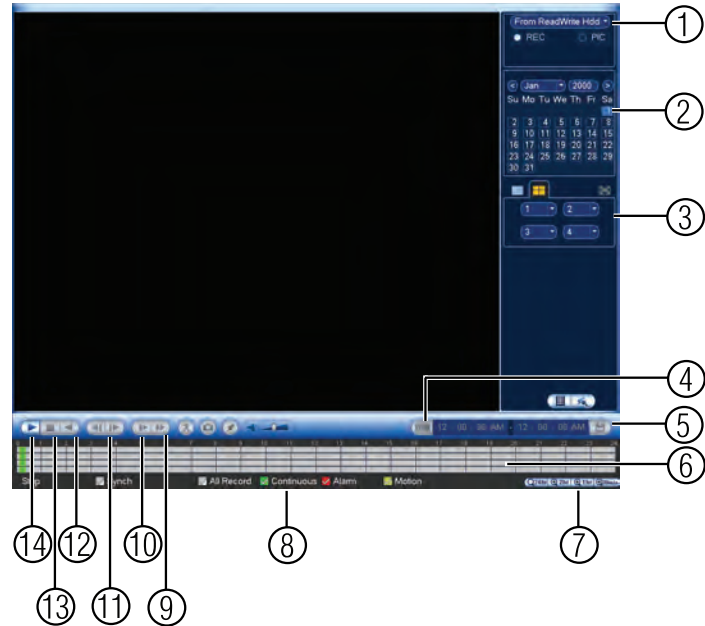

1. **Select playback device.**
2. **Calendar:** Select the day to playback.
3. **Channel select:** Select channels to playback.
4. **Video clip backup:** Select video clip start and end times.
5. **Backup video clip:** Click to save selected clip.
6. **Playback Bar:** Click inside the bar to select a playback time.
7. **Zoom Playback Bar:** Select scope of time bar.
8. **Recording types:** Click to show/hide recording types.
9. **Speed up**
10. **Slow**
11. **Previous/next frame**
12. **Play backward**
13. **Stop**
14. **Play**

10.3 Playing Back from a USB Drive

If you have video files saved to a USB thumb drive (not included) or external hard drive (not included), you can play them back using the system.

To play back from a USB drive:

1. Connect the USB thumb drive (not included) or USB external hard drive (not included) with video files on it into a USB port on the system.
2. From live view, right-click and click **Search**.
3. Log in using the system user name (default: **admin**) and password (default: **000000**).

-
- Click **From ReadWrite Hdd** and select **From IO Device**. Click **Browse** to open the USB drive and manually select the video file.

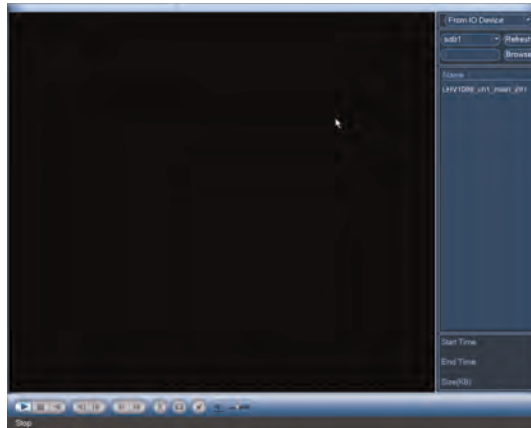

- Double click the video file you would like to open.

Backup video files to external USB flash drive (not included) or self-powered USB external hard drive (not included).



NOTE

USB external hard drives must be formatted in the FAT32 file format to be used with the system.

11.1 Formatting the USB Thumb Drive

It is recommended to format your USB thumb drive (not included) before using it with the system.



CAUTION

Formatting the USB device will permanently erase all data.

To format a USB device:

1. Insert a USB thumb drive (not included) into one of the USB ports.
2. From live view, right-click and then select **Main Menu**. Login if prompted.
3. Click  **>Backup**.
4. Click **Browse**.

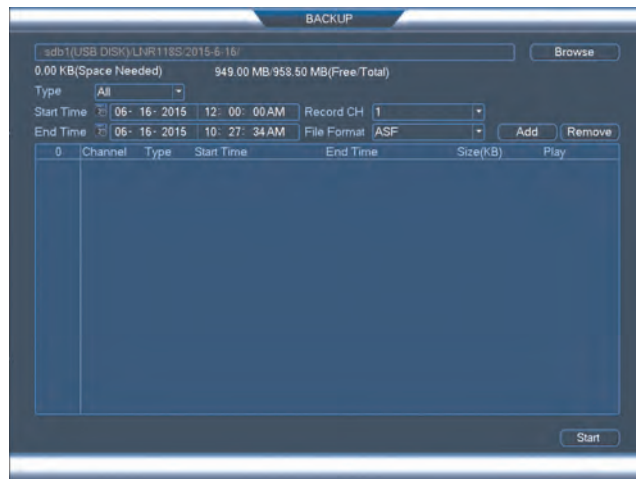

-
5. Select the USB device you would like to format under **Device Name** then click **OK**.

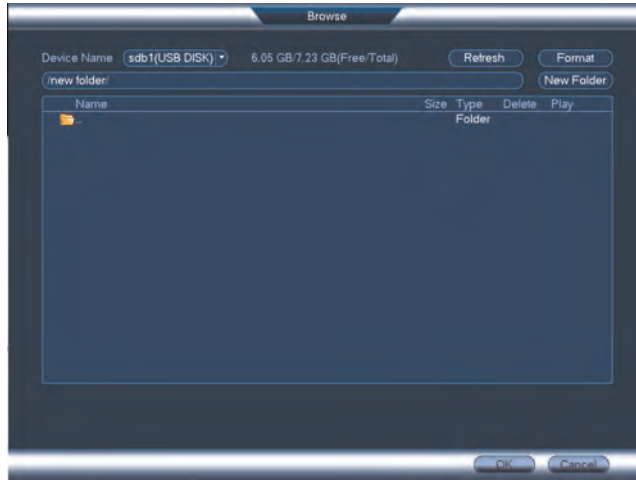

6. Click **Format**. Click **OK** to confirm.

11.2 Backing up Video

1. Insert a USB thumb drive (not included) into one of the USB ports.
2. From live view, right-click and then select **Main Menu**. Login if prompted.
3. Click  **Backup**.

4. Configure your search options:

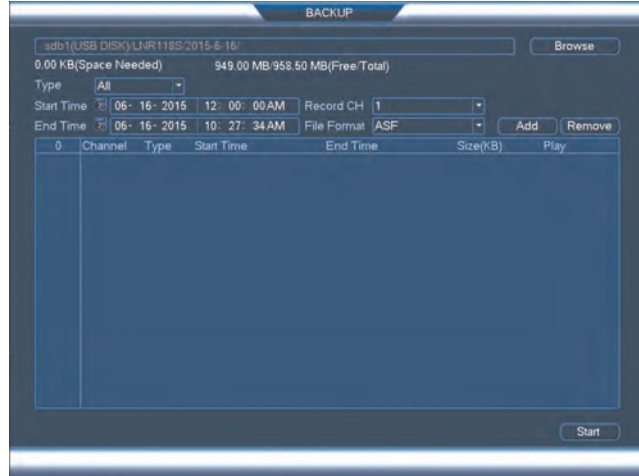

- Click **Browse** then select the USB device you would like to back up under **Device Name**. Click **OK**.
- **Type**: Select the recording type you would like to search for or select **All** to search all recording types.
- **Record CH**: Select the channel you would like to search or select **All** to search all channels.
- **File Format**: Select **DAV** to save files to .dav format. You can playback .dav files using the Lorex video player software from www.lorextechnology.com/support. Or, select **ASF** for .asf format. You can playback .asf files in VLC Media Player (free download from www.videolan.org) on PC or Mac.

**NOTE**

VLC Media Player is a free software available from www.videolan.org. VLC Media Player is not supported by Lorex.

- **Start Time/End Time**: Select the start and end time for your search.
5. Click **Add**. A list of files that match your search criteria appears.
 6. Check files you would like to backup and then click **Start**. Wait for the backup to complete.

**NOTE**



HD video files saved on the system may take up a large amount of disk space. The size of video files selected and the amount of free space on your USB device is shown at the top of the screen.

11.3 Using Video Clip Backup

Video clip backup allows you to select a duration of video during playback mode and save it to a USB device (not included).

To use Video Clip Backup:

1. Insert a USB thumb drive (not included) or USB external hard drive (not included) into one of the USB ports.
2. Start playing back video using the steps in 10.1 *Playing Back Video from the Hard Drive*, page 28.

3. Click  to mark the beginning of the video clip. Click  again to mark the end of the video clip.
4. Click  to open the Backup menu.
5. Configure the following:

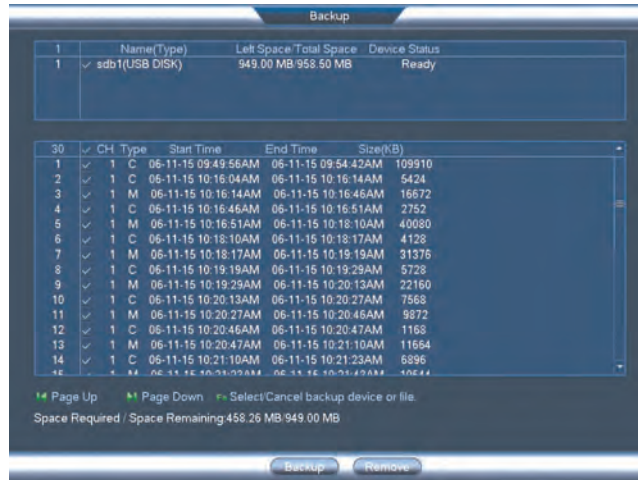

- 5.1. Check the USB device where you would like to save the file.
- 5.2. Check the files you would like to backup.
- 5.3. Click **Backup**. Then click **Start**. Wait for the backup to complete before removing the USB thumb drive.

11.4 Viewing Backup Files

To playback .dav backup video files, a Player is available for PC and Mac at www.lorextechnology.com/support.

11.4.1 Viewing Backup Files on PC

You can download **Video Player for PC** from www.lorextechnology.com/support.

To view backup video files using the Player on PC:

1. Download and install the **Video Player for PC** from www.lorextechnology.com/support.

2. Click  to open a back up video file.







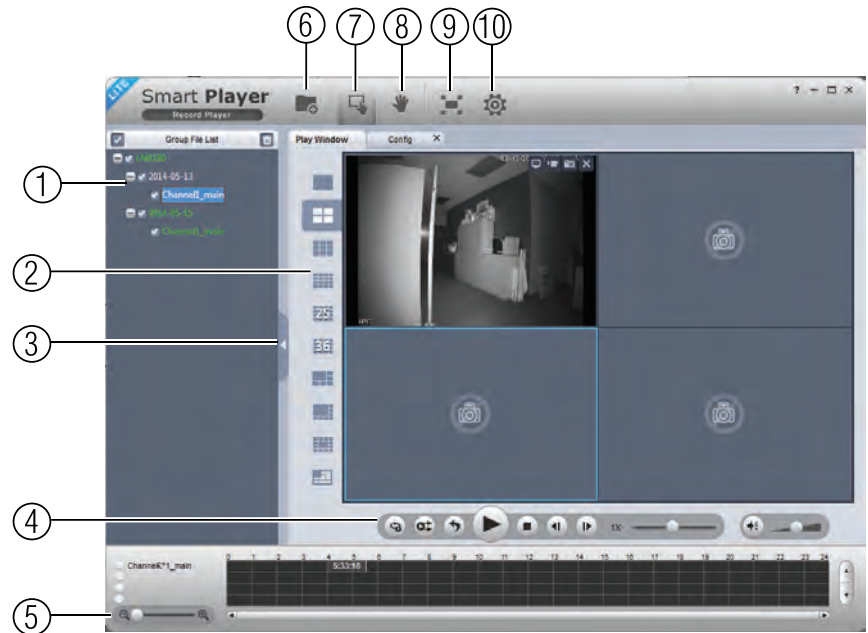







3. Use the Player controls to control playback or select other files for playback.

Video Player Controls

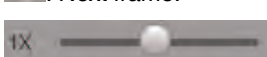

1. **File List:** Double-click to open a file.

-
2. **Display Area:** Select the split-screen mode. Double-click a video file to expand. Click the controls inside the display area to do the following:
 - : View information about the video file.
 - : Start/stop a manual recording from the video file.
 - : Take a snapshot from the video file.
 - : Close the video file.
 3. **Hide/show file list.**
 4. **Playback controls:**
 - : Playback files in sequence.
 - : Synchronize playback times.
 - : Play/pause playback.
 - : Stop playback.
 - : Previous frame.
 - : Next frame.
 - : Playback speed.
 - : Volume control.
 5. **Zoom Timeline.**
 6. **Add Files:** Click to open back up video files.
 7. **Digital Zoom:** Click to activate digital zoom mode. Click and drag in the video to zoom in. Right-click to unzoom.
 8. **Drag:** When digital zoom is activated, click to activate drag mode. Then click and drag in the video to view different areas of the image.
 9. **Full-screen:** Click to open the player in full screen. Press **ESC** to exit full screen.

10. **Config:** Click to open the configuration menu for the player. From here you can control the default file formats and save locations for snapshots and video files saved from the player.

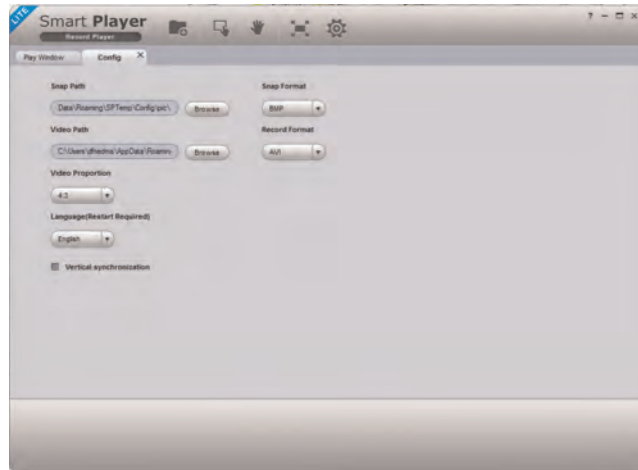

11.4.2 Viewing Backup Files on Mac

A Video Player for Mac is available from www.lorextechnology.com/support.

To view backup video files using the Player on Mac:

1. Download **Video Player for Mac** from www.lorextechnology.com/support.
2. Double click the downloaded file in Safari to extract the Smart Player app file.

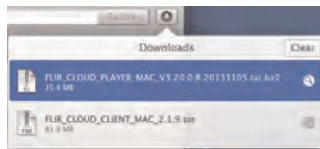

3. Drag the **Smart Player** app to your Desktop or Applications list. Double click **Smart Player** () to open it.

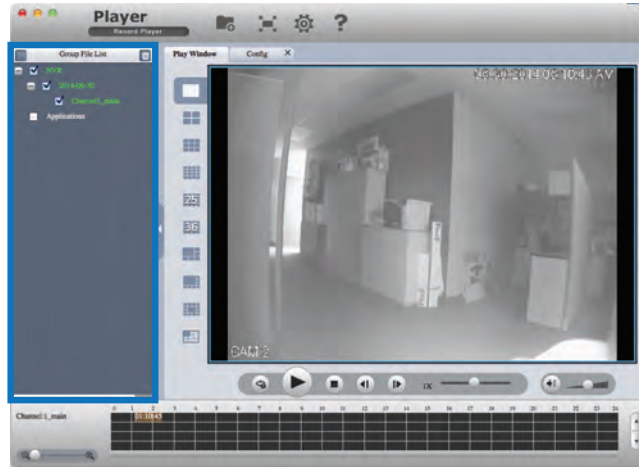

- Click  to open a backup video file in another location.



- Use the Player controls to control playback or select other files for playback.

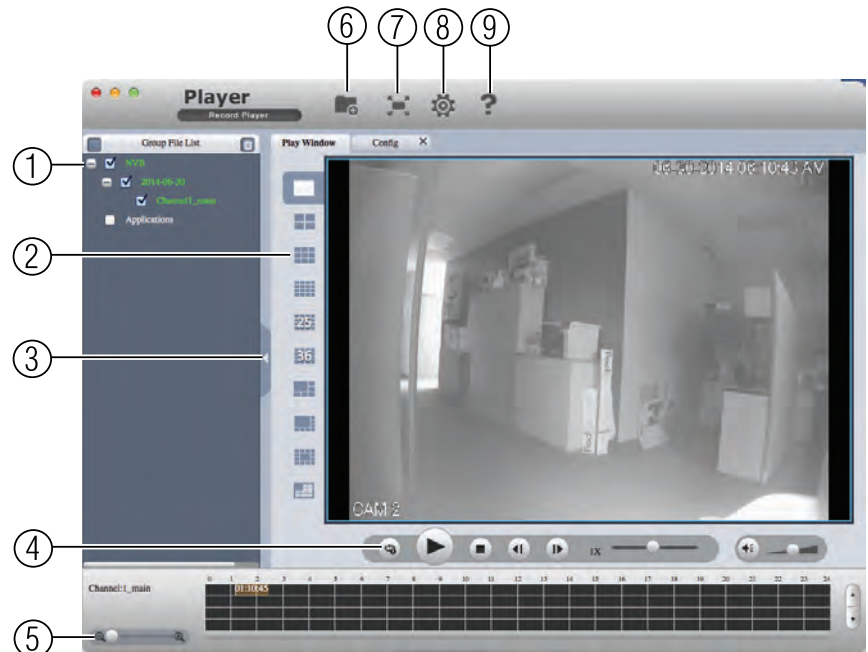





Video Player Controls



- File List:** Double-click to open a file.
- Display Area:** Select the split-screen mode. Double-click a video file to expand. Click the controls inside the display area to do the following:
 - : View information about the video file.
 - : Take a snapshot from the video file.
 - : Close the video file.

3. Hide/show file list.

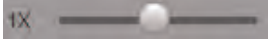
4. Playback controls:

- : When a video file ends, this button lets you select if you want the video player to repeat the same file or play the next file.
- : Play/pause playback.
- : Stop playback.
- : Previous file.
- : Next file.
- : Playback speed.
- : Volume control.

5. Zoom Timeline.

6. **Add Files:** Click to open back up video files.

7. **Full-screen:** Click to open the player in full screen. Press **ESC** to exit full screen.

8. **Config:** Click to open the configuration menu for the player. From here you can control the default file formats and save locations for snapshots and control the aspect ratio.



9. **About:** Click to see version information for the Player software.

Managing Passwords and User Accounts

By default, the system user name is **admin** and the password is **000000**. Passwords are enabled by default and are required to access the Main Menu or connect to the system using a computer or mobile device. You will be prompted to create a custom password after you connect for the first time.



NOTE

If you forget the password to the system, contact technical support to have it reset.

The system includes the following default accounts:



- **admin**: The admin account has full access to the system, may configure all system settings, and can manage user accounts.
- **default**: The default account is a limited user account that may only view live video from the cameras.

For security reasons, it is essential that you change the password on your system. **By default, the system password is enabled.**

12.1 Changing Passwords

You can change the system password of the admin and user accounts from the Users menu.

To modify an account password:

1. From Live View, right-click and then select **Main Menu**.
2. If prompted, enter the system user name (default: **admin**) and password (default: **000000**).
3. Click  and select **Setting**. Select **Account**.
4. Click  next to the user account you would like to modify.

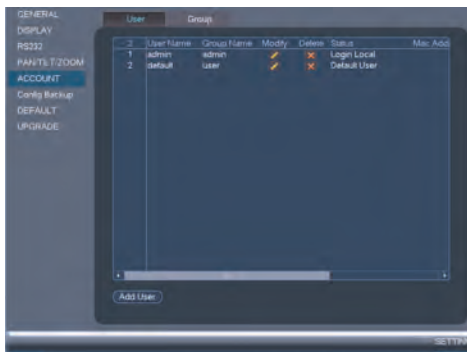

5. Check **Modify Password**.
6. Under **Old Password**, enter the account's previous password.
7. Under **New Password**, enter a new 6 character password for the account. Repeat the new password under **Confirm Password**.
8. Click **OK** to save changes.

12.2 Adding Users

You can allow multiple users to log in to the system. When adding different users, you can assign what menus they have access to. For example, you may want your friend to monitor your system while you are away, while not giving full access to your system.

To add a user account:

1. From Live View, right-click and then select **Main Menu**.
2. If prompted, enter the system user name (default: **admin**) and password (default: **000000**).
3. Click  and select **Setting**. Select **Account**.
4. Click **Add User**.
5. Configure the following:



- **User Name:** Enter a name for the user account.
 - **Password:** Enter a 6 character password for the user account. Enter the password again under **Confirm Password**.
 - **Memo (optional):** Enter a description of the user account.
 - **Group:** Select the group you would like to assign to this user account. A user account cannot be given permissions its group does not have.
 - **Multiuser:** Check to enable this user account to be used to login from more than one device at the same time.
 - **Authority:** Check the permissions you would like the user account to have. Under the **System** tab, select the menus the user account may access. Under the **Playback** tab, select which channels the user account may access recorded video from. Under the **Covert** tab, select the channels the user account may view live video from.
6. Click **OK** to save changes.

Now, you can log in to the system locally, or remotely using the user name and password you created. When logging into the system with a user account, the user will only have access to the menus you assigned.

12.3 Modifying Users

1. In the Account menu, click  next to the user account you would like to modify.
2. Update the user's account details as needed, and then click **OK** to save changes.

12.4 Deleting Users

1. In the Account menu, click  next to the user account you would like to delete.
2. Click **OK** to confirm.



NOTE

The admin and default user accounts cannot be deleted from the system.

12.5 Account Groups

Account groups can be used to easily manage permissions for multiple user accounts. User accounts can be given all the permissions of a group, but cannot be given permissions that the group does not have.

The system includes the following groups by default:

- **admin:** Accounts in the admin group are system administrators. They have full access to the system, may configure all system settings, and can manage user accounts.
- **user:** Accounts in the user group are normal users. They have limited access to system menus.

12.6 Adding Groups

1. From Live View, right-click and then select **Main Menu**.
2. If prompted, enter the system user name (default: **admin**) and password (default: **000000**).
3. Click  and select **Setting**.
4. Click **Account** and select the **Group** tab.
5. Click **Add Group**.

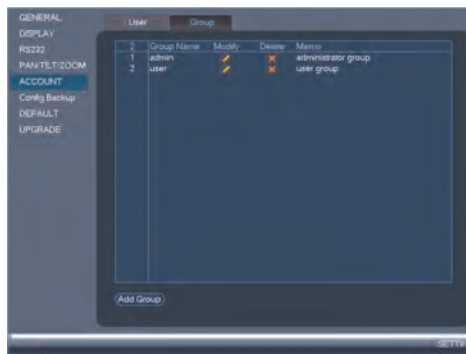

6. Configure the following:



- Under **Group Name**, enter a name for the group.
- Under **Memo**, enter an optional comment for this group.
- Under **Authority**, check the permissions that the group will have. User accounts assigned to this group can not be given any permissions the group does not have.

7. Click **OK** to save changes.

12.7 Modifying Groups

1. In the Group tab, click  next to the group you would like to modify.
2. Update the group's details as needed, and then click **OK** to save changes.

12.8 Deleting Groups

1. In the Account menu, click  next to the user account you would like to delete.
2. Click **OK** to confirm.

| | |
|---|-------------|
|  | NOTE |
| The admin and user groups cannot be deleted from the system. | |

To open the Main Menu:

- **Using the Mouse:** Right-click and click **Main Menu**.

**NOTE**

The system password may be required to access the Main Menu. By default the user name is **admin** and the password is **000000**.



1. **SEARCH:** Open Search/Playback mode. For details, see 10 *Search (Playback)*, page 28.
2. **BACKUP:** Export files to USB device. For details, see 11 *Backup*, page 31.
3. **CAMERA:** Open the menu to manage IP cameras connected to the network (see 6.11 *Connecting Cameras to the Local Area Network (LAN)* for details), set recording parameters, and assign custom titles for your cameras.
4. **INFO:** View system information.
5. **SETTING:** Configure general system, schedule, network, recording, display, and motion settings. Restore system to factory defaults.
6. **SHUTDOWN:** Logout, restart, or shutdown the system.

13.1 Camera

Open the Remote Device menu to manage IP cameras, set recording parameters, and assign custom titles for your cameras.

**13.1.1 Remote Device**

The Remote Device menus allow you to add cameras over the local area network (LAN), configure camera image settings, view camera status, and upgrade camera firmware.

- See 6.11 *Connecting Cameras to the Local Area Network (LAN)* for instructions on connecting cameras to the NVR over the network.
- See 8.3 *Adjusting Camera Image Settings*, page 18 for details on setting up camera image settings.

13.1.2 Viewing Camera Status

The Camera Status menu allows you to view the connection and alarm status for all connected cameras.

To view camera status:

1. From the Main Menu, click  and select **Remote Device>Status**.

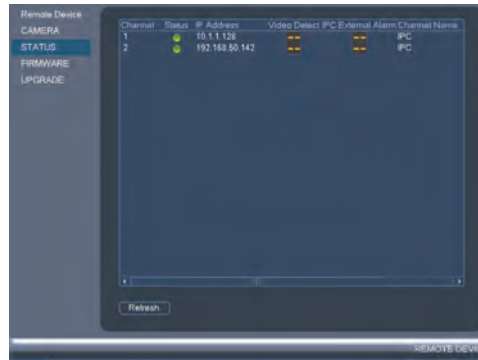

13.1.3 Viewing Camera Firmware Versions

You can use the Firmware menu to view firmware versions for connected cameras.

To view camera firmware versions:

1. From the Main Menu, click  and select **Remote Device>Firmware**.

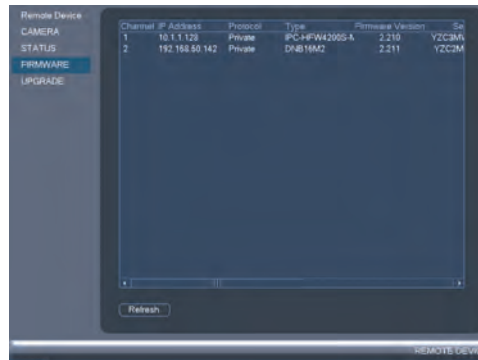

13.1.4 Upgrading Camera Firmware

You can update the firmware for connected IP cameras through the NVR. Firmware upgrades provide enhanced functionality for the cameras. Lorex provides firmware upgrades for free from www.lorextechnology.com/support.

To upgrade the camera firmware:

1. Download the camera firmware from www.lorextechnology.com/support if one is available.



NOTE

Make sure that the firmware file you are using is compatible with your IP camera model.

2. Extract the firmware file and copy it to a USB thumb drive (not included).

3. Insert the USB thumb drive (not included) into a USB port on the system.
4. Right-click and select **Main Menu**. Click  and select **Remote Device>Upgrade**.

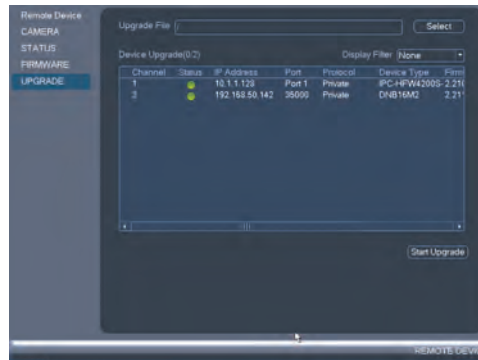

5. Click **Select**. Select the firmware file on the USB drive and click **OK**.
6. Check the cameras you would like to apply the upgrade to in the list and then click **Start Upgrade**.

**CAUTION**

Wait for the firmware upgrade to complete before turning off or unplugging the cameras or NVR. The cameras will restart during the firmware update process.

13.1.5 Recording

The Recording menu allows you to set recording parameters for your cameras, such as the resolution and frame rate.

13.1.6 Configuring Recording Quality

The system employs two video recording streams, a Main Stream and a Sub Stream. The Main Stream records high quality video to your system's hard drive. The Sub Stream records lower resolution video for efficient streaming to devices over the Internet. You can customize the video quality settings for these streams according to your needs.

To configure recording quality:

1. From the Main Menu, click  and select **Recording>Recording**.
2. Under **Channel**, select the camera you would like to configure.

- Configure the following settings. Settings for the Main Stream are in the left column. Settings for the Sub Stream are in the right column.

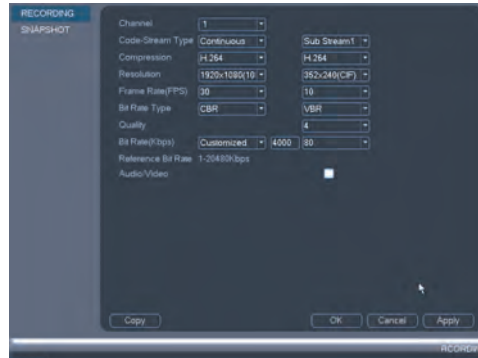

- Resolution:** Select the resolution that you want to use to record the selected channel. Higher resolutions create a more detailed image, but take up more hard drive space to record and require more bandwidth to stream to connected computers or mobile devices.

**NOTE**

Available resolutions for the Main Stream and Sub Stream depend on the model of camera that is connected to the system.

- Compression:** Select the video compression type that will be used. It is recommended to select **H.264**, as it will have the best performance and use the least amount of disk space.
- Frame Rate (FPS):** Select the frame rate in Frames Per Second (FPS) that each stream will record at. A higher frame rate provides a smoother picture, but requires more storage and bandwidth.
- Bit Rate Type:** Select **CBR** (Constant Bit Rate) or **VBR** (Variable Bit Rate) to determine the bit rate type. If you select VBR, you can set the video quality setting between 1 and 6. If you select VBR, select the **Quality** from **1** (lowest) to **6** (highest).
- Bit Rate (Kbps):** Select the bit rate for each recording stream. A higher bit rate results in a better image, but increases the amount of hard drive space or bandwidth required.

**NOTE**

The Audio/Video setting is not supported.

- (Optional) Click the **Copy** button to copy recording settings to other channels.
- Click **OK** to save changes.

13.1.7 Configuring Snapshot Recording Settings

The system can be set to record snapshot images when a camera detects motion. These snapshots can be viewed through the Search menu or can be attached to email alerts and push notifications. The Snapshot tab in the Recording menu controls the quality and recording parameters for each camera.

 **NOTE**

In order to enable Snapshot recording, the following menu options must be configured:

- The Snapshot schedule must be enabled for times that you would like to save snapshots. See 13.3.15 *Configuring the Snapshot Schedule*, page 65.
- Snapshot recording must be enabled for motion detection in the Event menu. See 13.3.8 *Configuring Motion Detection*, page 59.

To configure snapshot recording settings:

1. From the Main Menu, click  and select **Recording>Snapshot**.
2. Under **Snap Number**, select the number of snapshots the system will take when the snapshot button is pressed.
3. Configure the following settings for snapshots saved automatically from motion detection or the snapshot schedule:

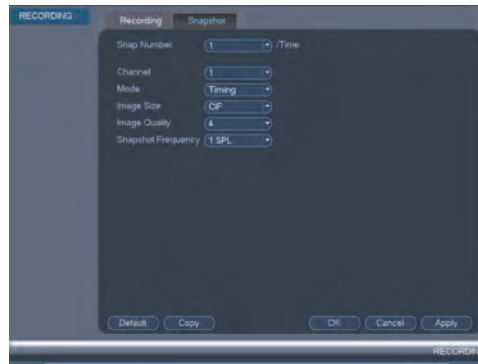

- **Channel:** Select the channel you would like to configure.
 - **Mode:** Select **Timing** for the system to take snapshots according to the snapshot schedule (see 13.3.15 *Configuring the Snapshot Schedule*, page 65) Select **Trigger** for the system to take snapshots only when triggered by motion detection (snapshot must be enabled in the Motion Detect menu; see 13.3.8 *Configuring Motion Detection*, page 59).
 - **Image Size:** The image size is the same as the Main Stream resolution of the camera.
 - **Image Quality:** Select the snapshot image quality between **1** (lowest) and **6** (highest)
 - **Snapshot Frequency:** Select the number of snapshots (up to 6) the system will take each time.
4. Click **OK** to save changes.

13.1.8 Creating Custom Channel Names

You can assign custom names to your cameras. For example, you can name your cameras based on their location (e.g. hallway or front door).

To create custom channel names:

1. From the Main Menu, click  and select **Channel Name**.

2. Enter a custom name for each channel.



3. Click **OK** to save changes.

13.2 Info

Info contains menus that show you system information.



13.2.1 HDD Info

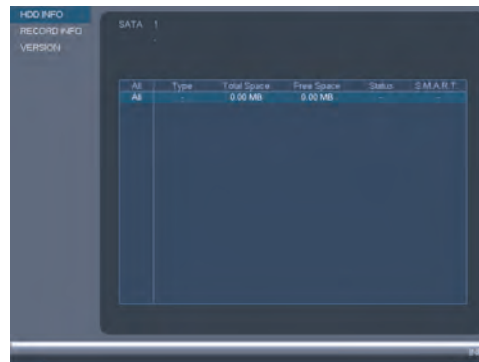

The HDD Info sub-menu shows information related to the hard drives installed in the system, including capacity, status, and type.

To access the HDD Info menu:

- From the Main Menu, click  and then click **Info>HDD Info**.

13.2.2 Record Info

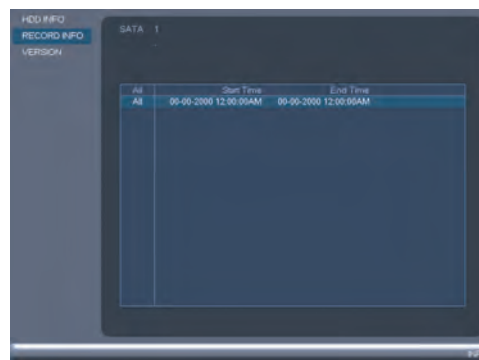

The Record Info menu shows the start and end times of recordings saved on the hard drive.

To access the Record Info menu:

- From the Main Menu, click  and then select **Info>Record Info**.

13.2.3 Version

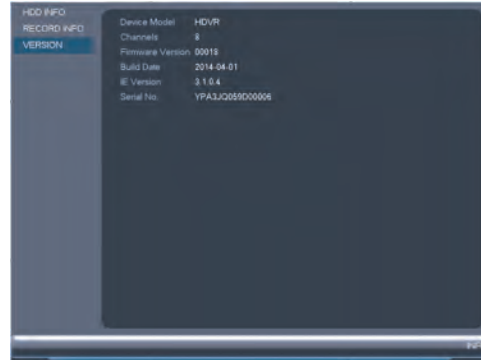

The Version sub-menu allows you to view information about the current firmware installed on the system.

To access the Version menu:

- From the Main Menu, click  and then click **Info>Version**.

13.2.4 Event Info

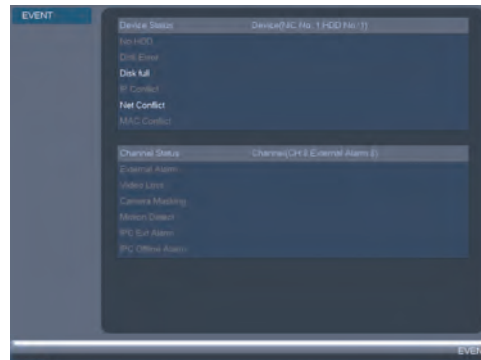

The Event Info menu shows you a display of system alarms. Activated alarms are highlighted in white. Additional info such as channels that are currently detecting motion is shown.

The following alarms are shown in the Alarm Status menu:

- No HDD:** No hard drive is detected.
- Disk Error:** Hard drive error detected.
- Disk Full:** Hard drive is full.
- IP Conflict:** More than one device on the network is using the same IP address.
- Net Conflict:** System is not connected to the network.
- MAC Conflict:** More than one device on the network is using the same MAC address.
- External Alarm:** Sensor/alarm device (not included) has been triggered.
- Video Loss:** Shows disconnected channels.

- **Camera Masking:** Camera masking alarm has been triggered (e.g. someone has covered the camera lens).
- **Motion Detect:** Shows channels with active motion alarms.
- **IPC Ext Alarm:** Alarm/sensor device (not included) connected to camera has been triggered.
- **IPC Offline Alarm:** IP camera is offline.

To access the Event Info menu:

- From the Main Menu, click  and then select **Event**.

13.2.5 Online Users

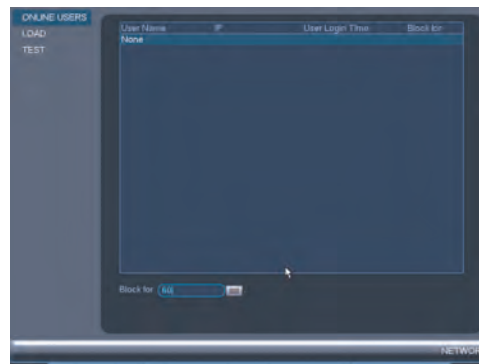

The Online Users menu shows a list of users connected to the system using computers or mobile devices.

To access Online Users:

- From the Main Menu, click  and then select **Network**.

13.2.6 Load



The Load menu shows you the network traffic your system is sending and receiving.

To access Load:

- From the Main Menu, click  and then select **Network>Load**.

13.2.7 Test

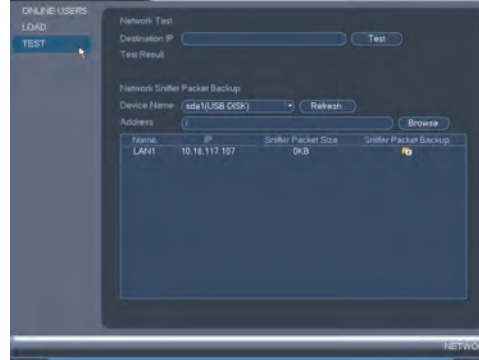

The Test menu allows you to test if your system can connect to other devices over the LAN or Internet. You can enter the IP address of a device and click **Test** to determine if your system can connect to it.

To access Test:

- From the Main Menu, click  and then select **Network>Test**.

13.2.8 BPS

The BPS sub-menu shows the bitrates of connected cameras. the bitrate is the amount of data the camera is sending to the system.

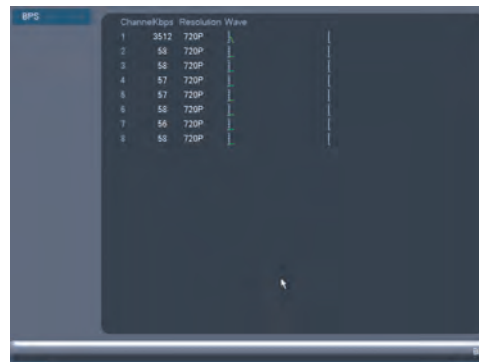

To access BPS:

- From the Main Menu, click  and then select **BPS**.

13.2.9 Log

The Log sub-menu allows you to search for system logs.

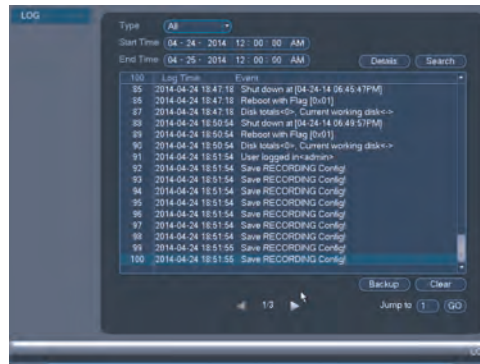

To search for system logs:

1. From the Main Menu, click  and then select **Log**.
2. Under **Type**, select the log type to search for.
3. Under **Start Time** and **End Time**, select the start and end time for your search.
4. Click **Search**.
5. (Optional) Click **Backup** to export logs to a USB thumb drive connected to the system.

13.3 Setting

The Setting menu allows you to configure general system, schedule, network, recording, display, and motion settings. It also allows you to restore the system to factory defaults.



13.3.1 Network

The Network menu allows you to configure network parameters for your system.

NOTE

The WiFi menu is not supported.

13.3.2 Selecting DHCP or Static IP Address (TCP/IP)

The TCP/IP menu allows you to configure IP address settings.

To configure IP address settings:

1. From the Main Menu, click  and then select **Network>TCP/IP**.

2. Check **DHCP** (recommended) to let the system automatically obtain an IP address from the router or uncheck to assign a static IP address.



If you uncheck DHCP, configure the following:

- **IP Address:** Enter the IP address you would like to assign to the system. Make sure that no other device on your network is using the same IP address.
- **Subnet Mask:** Enter the subnet mask for your network.
- **Default Gateway:** Enter the gateway address for your network.
- **Preferred DNS:** Enter the address of your primary DNS server.
- **Alternate DNS:** Enter the address of your secondary DNS server.

3. Click **OK** to save changes.

13.3.3 Configuring System Ports (Connection)

The Connection menu allows you to configure ports used by the system. Please note that port forwarding is not required to use FLIR Cloud™ or to connect using the apps.

If you are using DDNS connectivity, port forwarding is required for the HTTP Port (default: 80) and TCP (Client Port) (default: 35000).

To configure system ports:

1. From the Main Menu, click  and then select **Network>Connection**.



2. Configure the ports as needed and click **OK** to save changes.



NOTE

Up to 3 devices may connect to the system at the same time.

13.3.4 Configuring DDNS Settings

Lorex DDNS is available as an optional connectivity option. Please see 17 *DDNS Setup (Advanced)*, page 146 for details.

The primary connectivity option uses FLIR Cloud™ to connect to your system over the Internet without requiring port forwarding or DDNS registration. For details, see 14 *Connecting to Your System Over the Internet on PC or Mac*, page 74.

To configure DDNS Settings:

1. Visit <http://www.lorexddns.net> and register for a DDNS account.
2. From the Main Menu, click  and then select **Network>DDNS**.

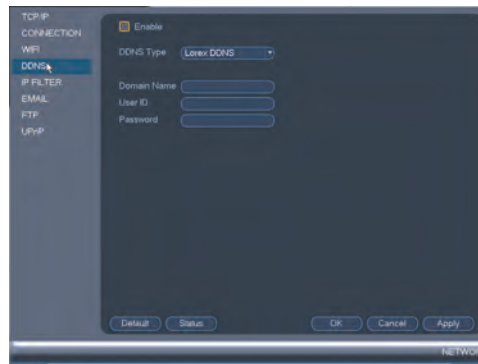

3. Check **Enable**.
4. Under **Domain Name**, enter the Domain Name/URL Request you received in the email after registering for DDNS.
5. Under **User Name**, enter your DDNS User Name.
6. Under **Password**, enter your DDNS Device password.
7. Click **OK** to save your settings.



NOTE

Please allow 10~15 minutes for the DDNS servers to update with your new DDNS address before attempting to connect.

13.3.5 Configuring Email Alerts

You can configure the system to send out email alerts for motion detection or other events.



NOTE

To send out motion detection alerts, you must enable the Send Email option for motion detection on each camera you would to receive alerts from. For details, see 13.3.8 *Configuring Motion Detection*, page 59.

To configure Email Alerts:

1. From the Main Menu, click  and then select **Network>Email**.

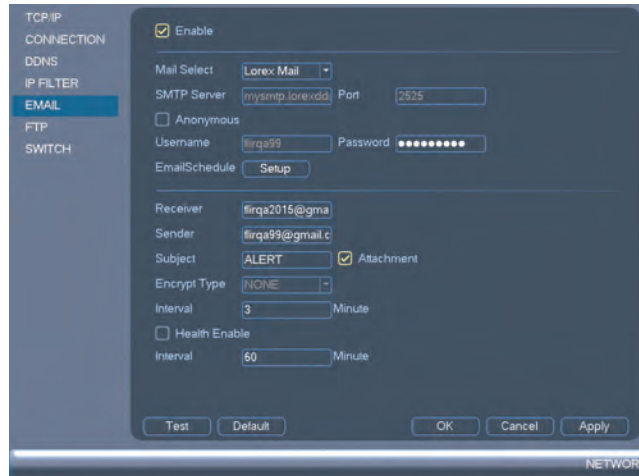

2. Check **Enable** to enable email notifications.

If you want to use Lorex's email server (recommended):

1. Under **Mail Select**, select **Lorex Mail** to use the Lorex email server to send out alarm notifications. This is the recommended setting.
2. Configure the following:
 - **EmailSchedule:** Click **Setup** and select the days you want email alerts to be enabled.
 - **Receiver:** Enter the email address that will receive alerts.
 - **Sender:** Enter the sender's email address.
 - **Subject:** Enter the subject line for the email alert.
 - **Interval:** Enter the interval between alert emails.
 - **Health Enable:** Check to enable health check emails. Health check emails will be sent periodically to ensure that the system is functioning normally. If you enable health check emails, enter the Interval in minutes below.

**NOTE**

You must enable the Snapshot option for motion detection on each camera you would to receive a jpg image attachment of the camera image. For details, see 13.3.8 *Configuring Motion Detection*, page 59.

3. Click **Test** to send a test email.
4. Click **OK** to save settings.

If you want to use Gmail or Yahoo Mail:

1. Under **Mail Select**, select **Gmail** or **Yahoo Mail**.

2. Configure the following:

- **Anonymous:** Check if your server supports anonymous log ins. Otherwise, leave this unchecked.
- **User Name:** Enter your Gmail user name.
- **Password:** Enter your Gmail password.
- **Receiver:** Enter the email address that will receive alerts.
- **Sender:** Enter the sender's email address.
- **Subject:** Enter the subject line for the email alert.

**NOTE**

You must enable the Snapshot option for motion detection on each camera you would to receive attachments. For details, see 13.3.8 *Configuring Motion Detection*, page 59.

- **Event Interval:** Enter the interval between alert emails.
- **Health Enable:** Check to enable health check emails. Health check emails will be sent periodically to ensure that the system is functioning normally.
- **Interval:** Enter the interval in minutes for health check emails.

3. Click **Test** to send a test email.4. Click **OK** to save settings.**NOTE**

Gmail and Yahoo Mail are not supported by Lorex. Gmail and Yahoo Mail SMTP information may change. Contact Google or Yahoo for support.

If you want to use your own email server (advanced):1. Under **Mail Select**, select **Custom**.

2. Configure the following:

- **SMTP Server:** Enter the SMTP server address.
- **Port:** Enter the port used by the SMTP server.
- **Anonymous:** Check if your server supports anonymous log ins. Otherwise, leave this unchecked.
- **User Name:** Enter the SMTP user name.
- **Password:** Enter the SMTP password.
- **Receiver:** Enter the email address that will receive alerts.
- **Sender:** Enter the sender's email address.
- **Subject:** Enter the subject line for the email alert.
- **Attachment:** Check to include a jpg image attachment of the camera.

**NOTE**

You must enable the Snapshot option for motion detection on each camera you would to receive attachments. For details, see 13.3.8 *Configuring Motion Detection*, page 59.

- **Encrypt Type:** Select **SSL** or **TLS** if your server uses encryption. Select **None** if your server does not use encryption.
- **Event Interval:** Enter the interval between alert emails.
- **Health Enable:** Check to enable health check emails. Health check emails will be sent periodically to ensure that the system is functioning normally.
- **Interval:** Enter the interval in minutes for health check emails.

3. Click **Test** to send a test email.4. Click **OK** to save settings.

13.3.6 Configuring Switch Settings (Advanced)

You can configure the networking settings for the internal PoE switch.

CAUTION

It is recommended to leave this menu on the default settings. Changing the information in this menu may disrupt the connection to the cameras.

To configure switch settings:

1. From live view, right-click and select **Main Menu**.
2. Click  > **Network** > **Switch**.
3. Configure the **IP Address**, **Subnet Mask**, and **Gateway** for the internal PoE switch.



4. Click **OK**. Click **Save** to save changes. The system will restart.

13.3.7 Event

The Event menu allows you to configure settings for motion detection, video loss, and system warnings.

13.3.8 Configuring Motion Detection

Motion Detection events allow the system to mark footage that has motion. This allows you to quickly locate relevant footage through Search. You can also configure system responses to motion detection events, such as activating the system buzzer or sending an email alert.

To configure Motion Detection events:

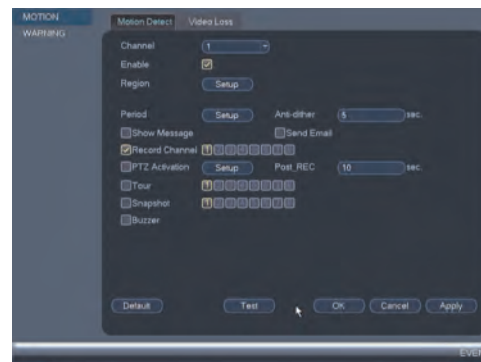

1. From the Main Menu, click  and then click **Event** > **Motion** > **Motion Detect**.

2. Under **Channel**, select the channel you would like to configure.
3. Check **Enable** to enable motion detection on the selected channel.
4. Click **Setup** next to Region to configure which areas of the image will be enabled for motion detection. A grid will appear on the monitor.

Motion Grid

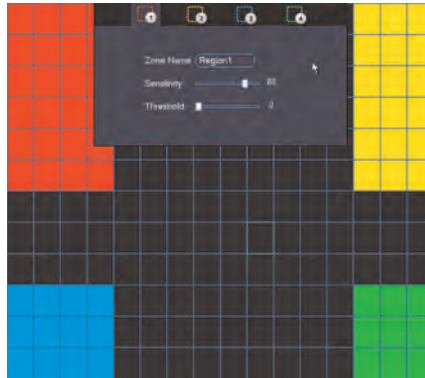

- Areas enabled for motion detection are shown in color and areas that are disabled are transparent.
 - Hover the mouse at the top of the screen to select which motion area you would like to configure. You can set up to 4 motion detection areas and customize the sensitivity and threshold for motion detection separately for each area between 0 (lowest) and 100 (highest).
 - The **Sensitivity** determines how sensitive the camera is to motion. For example, if the sensitivity is high, small amounts of motion are more likely to trigger an event. It is recommended to select a Sensitivity between 30~70.
 - The **Threshold** determines how much motion is required to trigger an event. If the amount of motion exceeds the threshold, an event occurs. It is recommended to select a Threshold between 10~50.
 - Right-click when finished.
5. Under **Anti-dither**, enter the anti-dither time. After a motion event occurs and motion stops, if motion is detected within the anti-dither time, the system continues the motion event and includes the new motion within the first event, rather than creating a new motion event.
 6. Under **Post_REC**, enter the time the system will record after a motion event occurs.
 7. To configure a schedule when motion detection will be enabled on this channel, click **Setup** next to Period. Configure times when motion detection will be enabled. For example, you may want to disable motion detection during business hours and enable it outside of business hours. Click **OK** when finished.



NOTE

This setting can override scheduled motion recording. This means that motion recording will only take place at times that are enabled both in the Schedule menu and here.

8. Configure the following system actions when motion is detected:
 - **Show Message:** Check to enable an on-screen pop-up when one of your cameras detects motion. On-screen pop-up shows the channels an event occurred on and the type of event.
 - **Channels:** Select the channels that will record when motion is detected on the selected channel.
 - **Send Email:** Check to enable email alerts. You must configure email alerts before you will be able to receive them (see 13.3.5 *Configuring Email Alerts*, page 56).
 - **PTZ Activation:** If you have PTZ cameras, check to set up your PTZ cameras to move to a specified preset when the camera detects motion. Click **Setup** to select the PTZ cameras you want to activate and specify the preset point each one will move to.
 - **Buzzer:** Check to enable the system buzzer.
 - **Snapshot:** Check to save a snapshot when the camera detects motion.
9. Click **OK** to save changes.

**NOTE**

Click **Test** to view a live view of the camera and see which areas of the screen trigger for motion. Areas where motion is detected will change color.

13.3.9 Configuring Video Loss Settings

Video Loss occurs if the system loses connection to one of the cameras.

To configure Video Loss settings:

1. From the Main Menu, click  and then click **Event>Motion>Video Loss**.

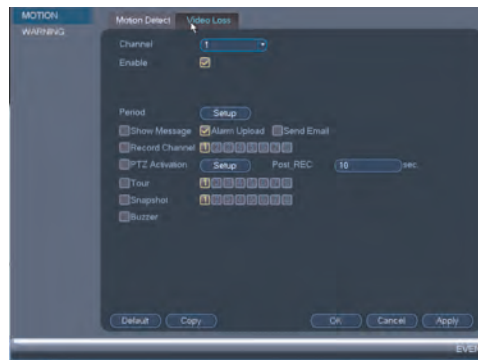

2. Under **Channel**, select the channel you would like to configure.
3. Check **Enable** to enable video loss events for the selected channel.

4. Configure the following to customize settings for video loss events:
 - **Period:** Click **Setup** to configure a schedule for video loss events. It is recommended to leave this on the default setting, so you can be alerted at any time one of your cameras loses video.
 - **Show Message:** Check to show a popup message on the monitor if one of your cameras loses video.
 - **Send Email:** Check to enable email alerts. You must configure email alerts before you will be able to receive them (see 13.3.5 *Configuring Email Alerts*, page 56).
 - **Channels:** Click the checkbox to enable video recording when video loss occurs. You can then select the channels the system will record when video loss occurs on the currently selected channel.
 - **PTZ Activation:** Check to enable PTZ actions when video loss occurs (PTZ camera required; not included). Click **Setup** to select which PTZ actions will be taken by each camera.
 - **Post_REC:** Enter the number of seconds the system will record after video loss occurs.
 - **Sequence:** Click the checkbox to enable sequence mode when video loss occurs. You can then select which channels will appear in sequence mode.
 - **Snapshot:** Click the box to enable snapshot recording when video loss occurs. You can then select which channels will save snapshots when video loss occurs on the currently selected channel.
 - **Buzzer:** Check to enable the system buzzer when video loss occurs on the currently selected channel.
5. Click **OK** to save changes.

13.3.10 Configuring Hard Drive Warnings

Hard drive warnings will notify you if an issue is detected with the hard drive.

To configure hard drive warnings:

1. From the Main Menu, click  and then click **Event>Warning>HDD**.

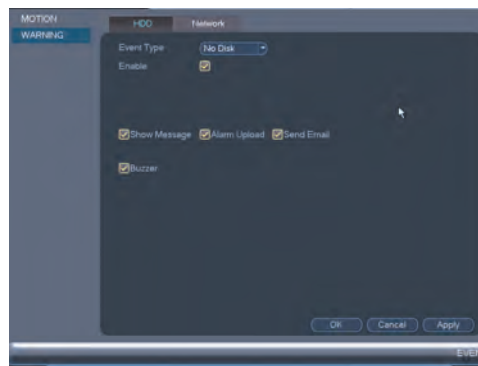

2. Under **Event Type**, select the hard drive event you would like to configure.
 - **No Disk:** No hard drive detected.
 - **Disk Error:** A hard drive error has been detected.
 - **Disk Full:** The hard drive is full or almost full. You can enter the percentage of disk space remaining that will trigger a warning under **Less Than** (e.g. when less than 10% of the hard drive is empty, trigger a warning). Disk Full warnings will not occur if overwrite is enabled.
 - **All:** Configure warnings for all hard drive events.

3. Configure the responses the system will take when the selected event occurs:
 - **Show Message:** Show a popup message on the monitor.
 - **Send Email:** Check to enable email alerts. You must configure email alerts before you will be able to receive them (see 13.3.5 *Configuring Email Alerts*, page 56).
 - **Buzzer:** Check to activate the system buzzer.
4. Click **OK** to save changes.

13.3.11 Configuring Network Warnings

Network warnings will notify you if there your system loses connection to the Internet or local network or if there is an issue on your network.

To configure network warnings:

1. From the Main Menu, click  and then click **Event>Warning>Network**.

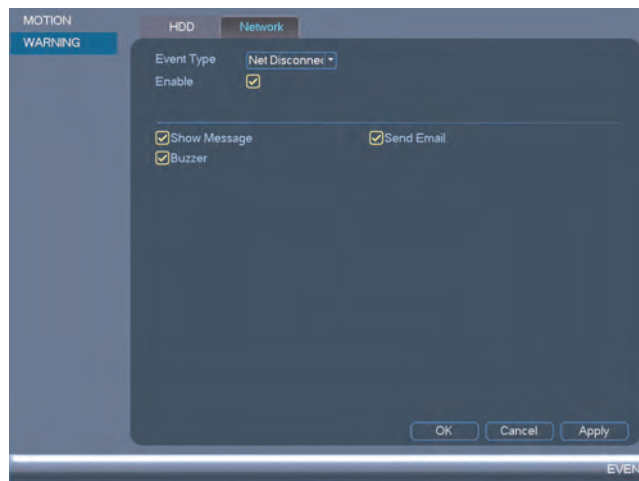

2. Under **Event Type**, select the event type you would like to configure.
 - **Net Disconnection:** The system has lost connection to the network.
 - **IP Conflict:** More than one device on your network has the same IP address.
 - **MAC Conflict:** More than one device on your network has the same MAC address.
 - **All:** Configure responses for all network events.
3. Configure the following for the selected event type:
 - **Enable:** Check to enable the selected event type.
 - **Show Message:** Check to show a popup message when the selected event occurs.
 - **Send Email:** Check to enable email alerts. You must configure email alerts before you will be able to receive them (see 13.3.5 *Configuring Email Alerts*, page 56).
 - **Buzzer:** Check to activate the system buzzer.
4. Click **OK** to save changes.

13.3.12 Storage

The Storage menu allows you to configure the recording schedule and hard drives connected to the system.

13.3.13 Configuring the Video Recording Schedule





You can set a custom recording schedule according to your needs. For example, you can set the system to record continuously during business hours and record on motion detection only outside of business hours.

A custom recording schedule helps reduce the amount of hard drive space required, increasing the time your system can retain recordings.

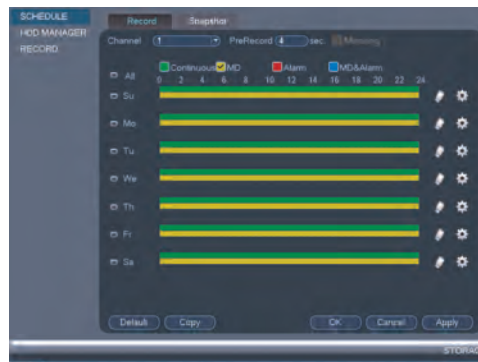
To configure the video recording schedule:

1. From the Main Menu, click  and then click **Storage>Schedule>Record**.
2. Under **Channel**, select the channel you would like to configure or select **All**.
3. Configure the schedule as needed:



- Check **Continuous** or **MD** (motion detection) to select the recording type you would like to configure.
 - Click and drag on each day to customize the recording schedule. The schedule is set up as a grid, which each block representing one hour.
 - Click  next to All to link the recording schedules for all days. The icon for a day changes to  when days are linked. You can also click the boxes next to individual days to link them to each other. If the recording schedule is linked, changes made to one of the days will apply to every day that is linked.
 - Click  to disable all recording of the selected type on the selected day.
 - Click  if you need to set a more precise schedule down to the minute.
4. Click **OK** to save changes.

13.3.14 Configuring Pre-Recording

The system can pre-record video when motion detection events occur.

To configure pre-recording:

1. From the Main Menu, click  and then click **Storage>Schedule>Record**.

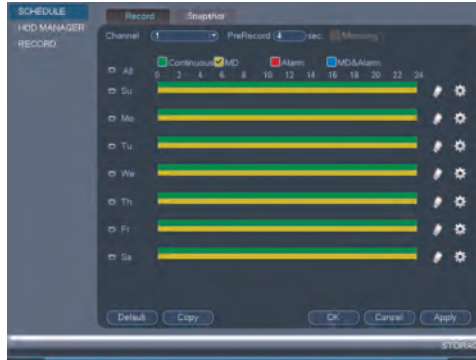

2. Under **Channel**, select the camera you would like to configure or select **All**.
3. Under **PreRecord**, select the duration for pre-recording.
4. Click **OK** to save settings.

13.3.15 Configuring the Snapshot Schedule

You can set a schedule for recording snapshots from the cameras.





To set up the snapshot schedule:

1. From the Main Menu, click  and then click **Storage>Schedule>Snapshot**.



2. Under **Channel**, select the channel you would like to configure or select **All**.

3. Configure the schedule as needed:

- Check **Continuous** or **MD** (motion detection) to select the recording type you would like to configure.
- Click and drag on each day to customize the recording schedule. The schedule is set up as a grid, which each block representing one hour.
- Click  next to All to link the recording schedules for all days. The icon for a day changes to  when it is linked. You can also click the boxes next to individual days to link them to each other. If the recording schedule is linked, changes made to one of the days will apply to every day that is linked.
- Click  to disable all recording of the selected type on the selected day.
- Click  if you need to set a more precise schedule down to the minute.

4. Click **OK** to save changes.**13.3.16 Configuring Holidays**

You can set certain days as holidays. Holidays have a special recording schedule.

To configure holidays:

1. From the Main Menu, click  and then click **Setting>General>Holiday**.

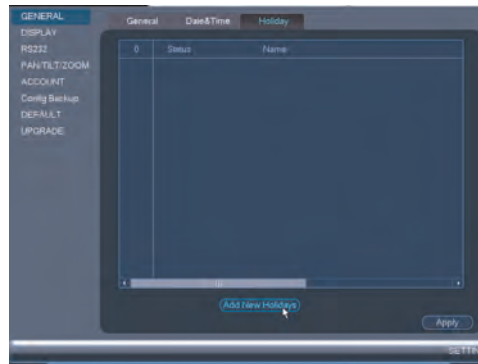

2. Click **Add New Holidays**.

- Configure the following:

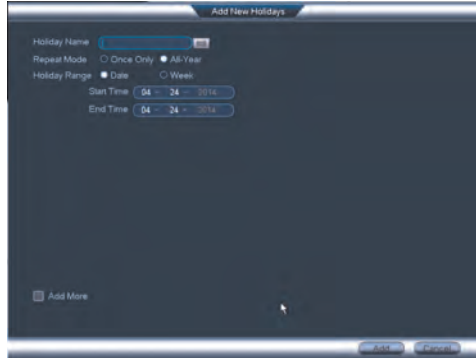

- **Holiday Name:** Enter a name for this holiday.
 - **Repeat Mode:** Select **Once** for the holiday to occur only this year or **Always** for the holiday to be repeated each year.
 - **Holiday Range:** Select **Date** to select a specific date, or select **Week** to select holidays based on which week they fall on.
- Click **Add**. Now that you have added a holiday, an extra holiday setting is added to the recording schedule.

**NOTE**

You cannot delete holidays, but you can disable them by selecting **Stop** under the **Status** drop-down and then click **Apply**.

- Click **OK**.

13.3.17 Formatting the Hard Drive

The HDD Manager menu allows you to format the hard drive. If you install a new hard drive, you must format the hard drive using the system before you will be able to record.

To format the hard drive:

**CAUTION**

Formatting the hard drive erases **all data** on the hard drive. **This step cannot be undone.**

- From the Main Menu, click  and then click **Storage>HDD Manager**.

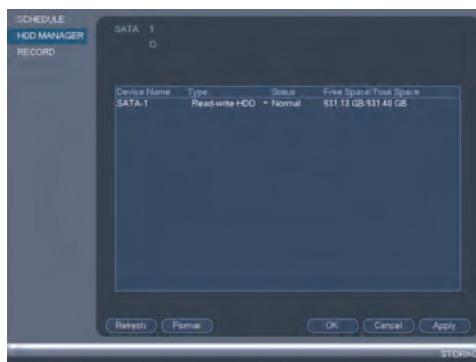

2. Select the hard drive you would like to format and then click **Format**. Click **OK** to confirm.
3. Click **OK** to save changes. The system will restart to complete the formatting process.

13.3.18 Configuring Hard Drive Type

The system supports the following hard drive types:

- **Read-write HDD:** Normal recording hard drive.
- **Read-only HDD:** The system can playback data from this hard drive, but it will not record to it.

To set the hard drive type:

1. From the Main Menu, click  and then click **Storage>HDD Manager**.

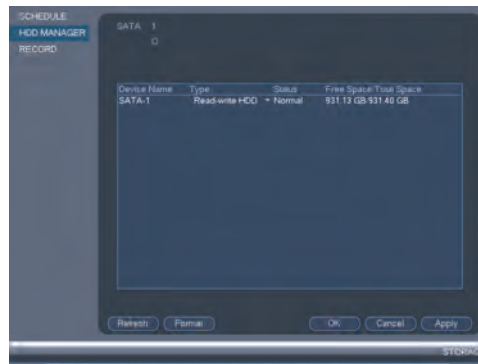

2. Click the hard drive you would like to configure.
3. Under **Type**, select **Read-write HDD** or **Read-only HDD**.
4. Click **OK** to save changes. The system will restart to complete this operation.

13.3.19 Configuring General System Settings

You can use the General menu to configure miscellaneous system settings.

To configure general settings:

1. From the Main Menu, click  and then click **Setting>General>General**.

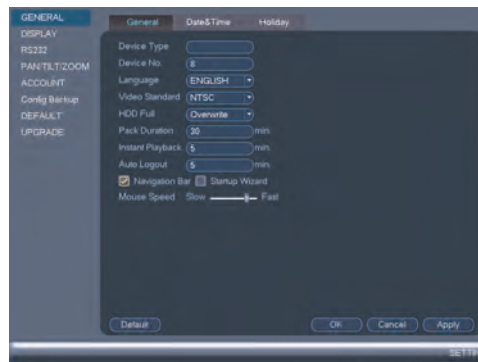

2. Configure the following:

- **Device No.:** Not supported.
- **Language:** Set the system languages. Available options are English, French, and Spanish.
- **Video Standard:** Select **NTSC** (North America) or **PAL** (Europe).
- **HDD Full:** Select **Overwrite** for the system to overwrite the oldest recordings when the hard drive is full or select **Stop Record** for the system to stop recording when the hard drive is full.
- **Pack Duration:** Select how the duration (in minutes) the system will store video files. For example, if this is set to 30 minutes, the system will create a new video file for each 30 minutes of continuous recording.
- **Instant Playback:** Select the amount of time (in minutes) the system will go back when instant playback is activated in live view.
- **Auto Logout:** Select the idle time (in minutes) before the system will logout the current user.
- **Navigation Bar:** Check to enable the Navigation Bar that comes up when you left click in live view.
- **Startup Wizard:** Check to enable a setup wizard when you start up the system.
- **Mouse Sensitivity:** Use the slider to adjust the mouse sensitivity.

3. Click **OK** to save changes.

13.3.20 Setting the Monitor Resolution (Display)

The Display menu allows you to configure the systems monitor resolution and other display settings.

To set the monitor resolution:

1. From the Main Menu, click  and then click **Setting>Display>Display**.

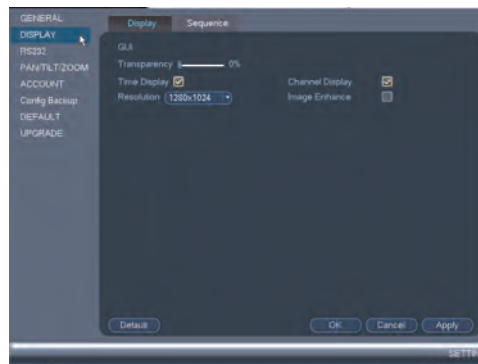

2. Under **Resolution**, select the correct resolution for your monitor: **1920x1080**, **1280x1024**, **1280x720**, or **1024x768**.
3. Click **OK** to save changes. Click **OK** again to restart the system using the new resolution.

To configure other display settings:

- From the Main Menu, click  and then click **Setting>Display>Display**.

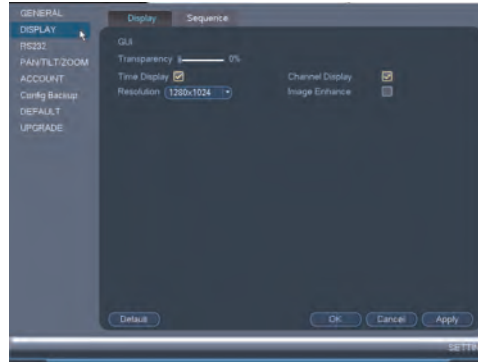

- Configure the following:
 - **Transparency:** Select the menu transparency.
 - **Time Display:** Check to show the time on the monitor.
 - **Channel Display:** Check to show the channel names on the monitor.
 - **Image Enhance:** Check for the system to digitally improve the video quality on the live display. This setting does not affect recordings.
 - **Original Scale:** Select channels to display the original aspect ratio of the camera.
- Click **OK** to save changes.

13.3.21 Saving Your System Configuration to a USB Thumb Drive

The system allows you to save your current system configuration to a USB thumb drive (not included). This is useful if you want to backup your current settings.

NOTE

This function only saves settings created in system menus. It does not save or backup any video.

To save your system configuration to a USB thumb drive:

- Insert a USB thumb drive (not included) into one of the USB ports.
- From the Main Menu, click  and then click **Setting>Config Backup**.



3. Under **Device Name**, select the USB device where you would like to save the configuration.
4. Click **Export** to save your current system configuration.

To restore a saved system configuration:

1. Insert a USB thumb drive (not included) with a saved system configuration into one of the USB ports.
2. From the Main Menu, click  and then click **Setting>Config Backup**.



3. Under **Device Name**, select the USB device.
4. Click the folder with the configuration files you would like to restore. Configuration file folders are labeled “Config” and then the time and date the configuration was saved (e. g. *Config_20140425103727*).
5. Click **Import** to restore the system configuration.
6. Click **Apply** to confirm. The system will restart to complete the operation.

13.3.22 Setting the System to Factory Defaults

The Default menu allows you to reset the system to factory default settings.

To reset the system to factory default settings:

1. From the Main Menu, click  and then click **Setting>Default**.

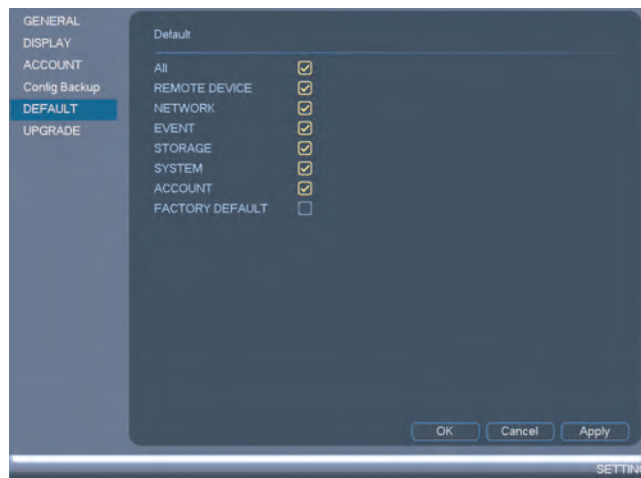

2. Check the menus you would like to reset to default settings.

3. Click **OK**.

13.3.23 Upgrading Firmware from USB

Firmware upgrades provide enhanced functionality. The system will automatically check for firmware upgrades if it is connected to the Internet. The system also supports firmware upgrades from a USB thumb drive (not included).

To upgrade firmware from a USB drive:

1. Download the firmware upgrade from www.lorextechnology.com/support.
2. Extract the firmware file and copy the firmware to a blank USB thumb drive.



NOTE

Do not have any folders on the USB thumb drive—just the firmware file.

3. Insert the USB thumb drive to a USB port on the system.
4. Right-click and then click **Main Menu**. Click  **>Setting>Upgrade**.

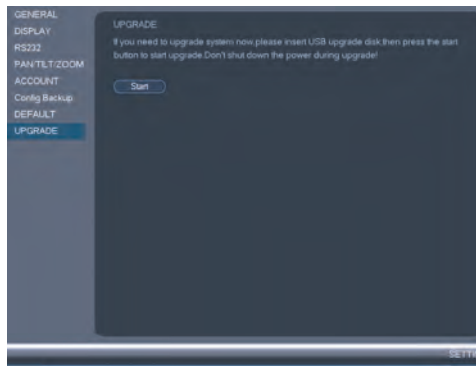

5. Click **Upgrade**.
6. Select the firmware file on the USB drive and click **Upgrade**.



WARNING

DO NOT POWER OFF THE SYSTEM OR DISCONNECT THE POWER CABLE DURING FIRMWARE INSTALLATION

13.4 Shutdown

Use the Shutdown menu to shutdown, restart, or log out of the system.

To access the Shutdown menu:

1. From live view, right-click and select **Main Menu**.
2. Enter the system User Name (default: **admin**) and Password (default: **000000**) and click **OK**.
3. Click  **>Shutdown**.
4. Select one of the following:



- **Logout:** Log out the account that is currently active.
- **Shutdown.**
- **Restart.**

Connecting to Your System Over the Internet on PC or Mac

This system features connectivity using the exclusive FLIR Cloud™. This cloud-enabled service allows for Internet connectivity without requiring any network configuration. Up to 3 devices may connect to the system at the same time.

NOTE

- Except where noted, the PC and Mac instructions in this section are the same.
- For smartphone/tablet setup, see 16 *Connecting to your System Using Smartphone or Tablet Apps*, page 105.
- For the latest list of supported apps and devices, visit www.lorextechnology.com/support.



14.1 System Requirements

Your system must meet the system requirements below:

| Description | Requirement |
|------------------|--|
| CPU | Core 2 Duo 3.0GHz |
| Operating System | Windows™ 8/7/Vista Mac OSX 10.7 and above |
| Memory | 2GB |
| Video | 512 MB of video memory and above |
| Network (LAN) | 10/100 BaseT Network |
| Network (WAN) | 1 Mbps upstream High-speed Internet service is required to remotely connect to your system. |

14.2 Step 1 of 3: Connect your System to Your Router

1. Power off your system by disconnecting the power adapter.
2. Connect an Ethernet cable (included) to the **LAN** port on the rear panel of the system. Connect the other end of the Ethernet cable to an empty LAN port (usually numbered 1~4) on your router.

3. Reconnect the power adapter to power the system back on.

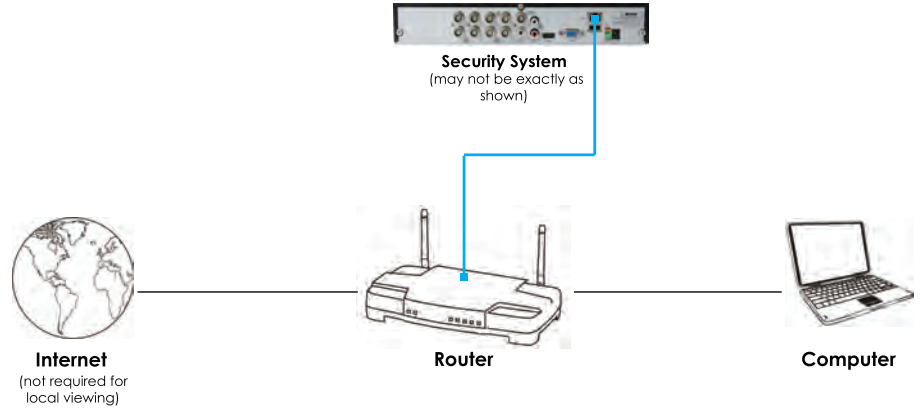

14.3 Step 2 of 3: Obtain the system's Device ID

The Device ID is a unique code that allows your system to handshake with FLIR Cloud™ servers for a secure connection over the Internet.

To find the Device ID:

1. The Device ID is located on a sticker on the system.



2. Write down the **Device ID** of the system.

14.4 Step 3 of 3: Connect to the System Over the Internet

Follow the steps below to connect to the system over the Internet.

NOTE

Make sure to upgrade your system to the latest firmware version. You must have the latest firmware and client software to connect to the system over the Internet.

To connect to the system over the Internet:

1. Download and install the client software.
 - **PC Users:** Download and install the **Client Software for PC** from www.lorextechnology.com/support.
 - **Mac Users:** Download and install the **Client Software for Mac** from www.lorextechnology.com/support. Double click to extract the software. Then, drag the software to **Applications**.
2. Once installation is finished, double-click the FLIR Cloud™ Client icon (📎) from the desktop or Applications list.

- Log into the Client Software using the Client Software user name (default: **admin**) and password (default: **admin**) and then click **Login**.

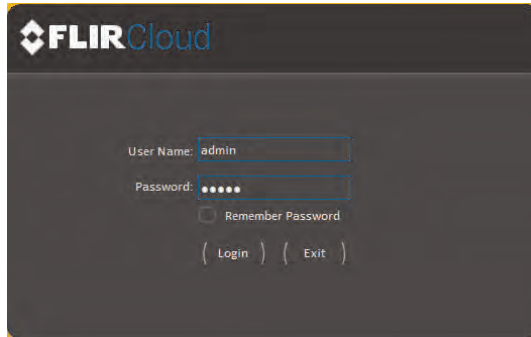

- Click **Add Device**.

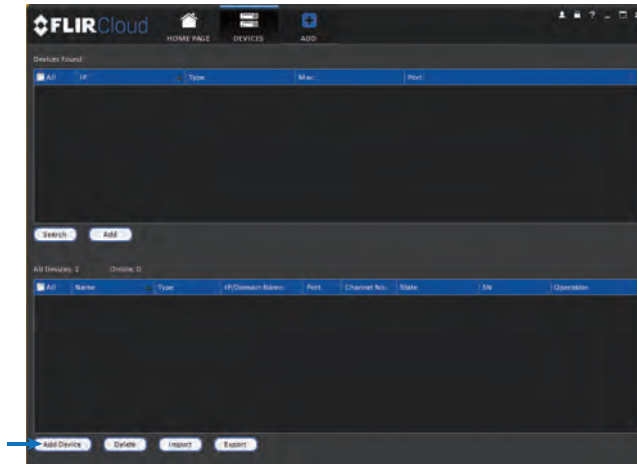

- Enter the following:

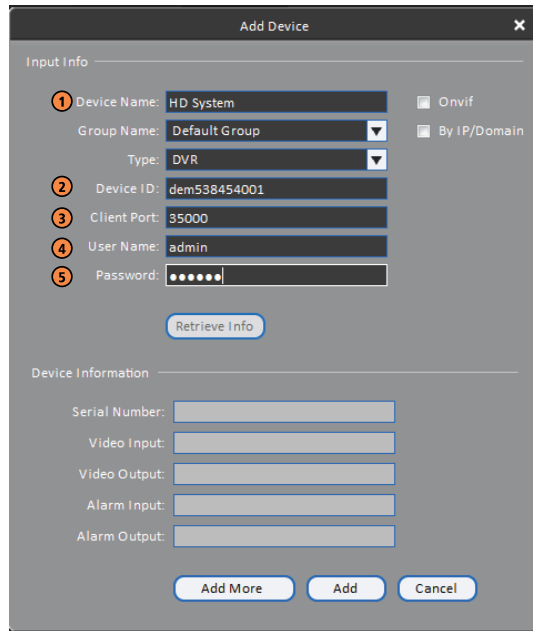

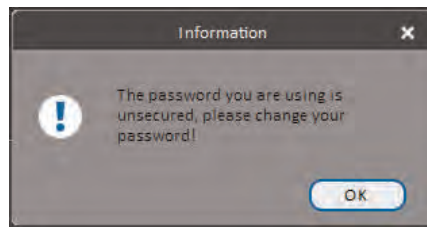

- 5.1. **Device Name:** Choose a name for your system of your choice.
 - 5.2. **Device ID:** Manually enter the Device ID printed on the label.
 - 5.3. **Client Port:** Enter the Client Port (default: **35000**).
 - 5.4. **User Name:** Enter the system User Name (default: **admin**).
 - 5.5. **Password:** Enter the system Password (default: **000000**).
6. Click **Add**. If this is the first time you are connecting, you will be prompted to change the system password.

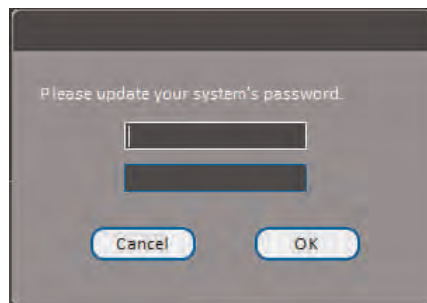

7. Enter a new 6 character password and click **OK**. This password will be used to connect to your system from now on.



8. Click  then .

9. Click and drag **Default Group** to the display window to open your cameras in live view.

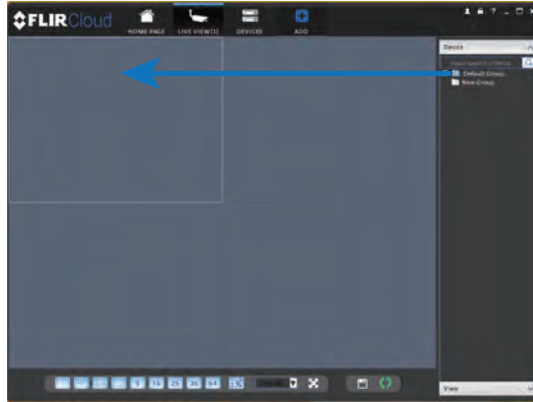

Congratulations! You can now connect over the Internet to view and playback video on your computer.



Using FLIR Cloud™ Client for PC or Mac

FLIR Cloud™ Client allows you to connect to multiple systems from a PC or Mac.

15.1 Home Page

The Home Page allows you to access all the tabs within the software. Each tab allows you to access different features.





To open tabs:

Click a tab from the Home Page to open it or click the  button at the top of the screen from within any tab to open a new tab.

15.2 Live View

The Live View tab is where you can view live video from connected systems.

To view live video from a system:

1. Click  and then click  to create a Live View tab.
2. Click and drag a DVR, NVR, group, or individual camera to open live video. To access individual cameras, you can click + to expand groups or systems.



15.2.1 Live View Controls



1. **Live display:** Double-click to expand the area. Right-click to access additional options. Hold the mouse over the display area to access the camera toolbar.

Camera toolbar:

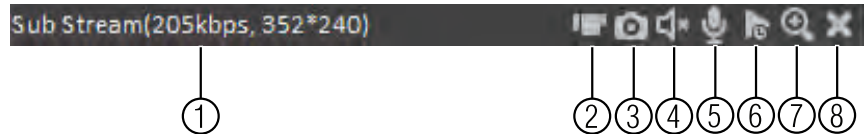



- 1.1. **Streaming quality:** Shows the bitrate and resolution for the stream, and shows if display is showing the Sub Stream or Main Stream.
 - 1.2. **Manual recording:** Click to start/stop manual recording.
 - 1.3. **Snapshot:** Click to save a snapshot.
 - 1.4. **Mute/unmute:** Click to mute/unmute audio (audio camera required).
 - 1.5. **Not supported.**
 - 1.6. **Instant playback:** Plays back the most recently recorded video from the camera. By default, it will play back the last 5 minutes of recorded video from the camera.
 - 1.7. **Digital zoom:** Click to enable digital zoom mode. Click and drag over the display area to zoom on the camera. Then click and drag to pan. Click the icon again to zoom out.
 - 1.8. **Disconnect.**
1. **Split-screen mode:** Click to select split-screen layout.



2. **Aspect ratio:** Use the drop down menu to select the aspect ratio for the selected camera. **Original** uses the actual aspect ratio of the image. **Full-win** stretches the image to fill up the entire display area.



-
3.  **Full-screen:** Click to open full-screen mode. Press **ESC** to exit full-screen mode.
 4.  **Save view:** Click to save the current display layout and open cameras as a view. Then enter a name for the view.
 5.  **Start/stop tour:** Click to start the tour. During the tour the client will cycle through all saved views every few seconds. Click again to stop the tour.
 6. **PTZ Controls:** Controls for PTZ cameras (not included). See 15.3 *Controlling PTZ Cameras*, page 82 for details.
 7. **View:** Click **View** to access view menu. Then double-click on a view to open it in the display area.

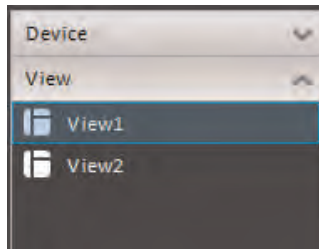

8. **Devices:** Shows a list of groups, cameras, and systems connected to the client. Drag items to the display area to open live video. Right-click to view additional options.

15.2.2 Opening Live View in Multiple Monitors

If your computer has multiple monitors, you can open more than one Live View tab and move them to secondary monitors. This allows you to monitor cameras on multiple monitors at the same time.



NOTE

Using multiple monitors significantly increases the amount of computing resources necessary to run the application and may affect performance.

To open Live View in multiple monitors:

1. Click  and then click  to create a Live View tab.

- Click and drag the tab outside of the client window to create a new window. You can drag the window to one of the secondary monitors.

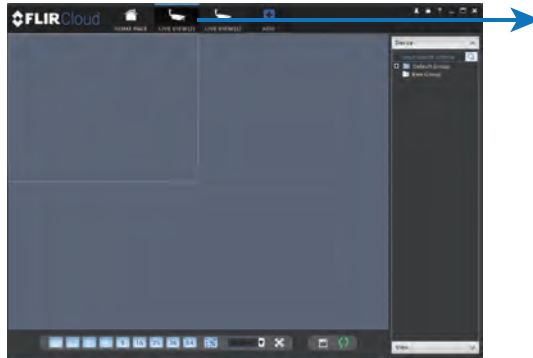

Result



15.3 Controlling PTZ Cameras

If you have PTZ cameras (not included), you can control them using the client.

NOTE

You must ensure the PTZ camera is properly connected to your system and your system is configured to detect it before you can control them using the client.

To control PTZ cameras:

- Click the display area with the PTZ cameras and use the on-screen PTZ controls.

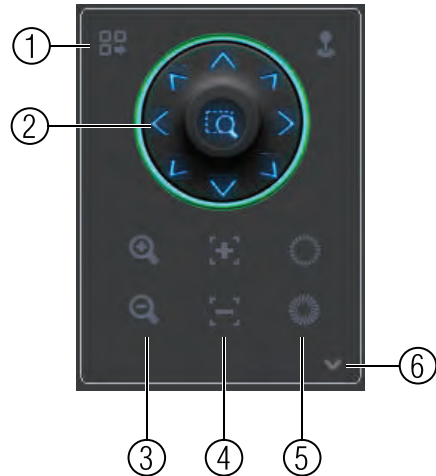

PTZ controls:

1. **Open menu:** Click to open camera OSD menu controls. This feature may not be supported for all camera models.
2. **Move camera:** Click the arrows to move the camera.
Click  to open dynamic zoom mode. Then click and drag in the video area to zoom in the camera on an area.
3. **Zoom +/-:** Click to zoom the camera in and out.
4. **Focus +/-:** Click to increase/decrease the focus.
5. **Iris +/-:** Click to increase/decrease the iris.
6. **Advanced:** Click to access advanced PTZ controls.

15.3.1 PTZ Presets

Presets will save a camera position for quick retrieval.

To add presets:

1. Click  to open the Advanced controls. Select **Preset**.
2. Click .

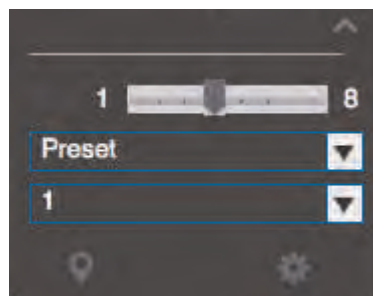

3. Select the number of the preset you would like to add.



4. Move the camera to the desired position.
5. Click  to save the current position as a preset.



To go to a saved preset:

1. Select the preset number from the list or click  to go to the currently selected preset.

15.3.2 PTZ Tours

Tours will cycle through a set of presets.

To configure a PTZ tour:

1. Click  to open the Advanced controls. Select **Tour**.
2. Click .

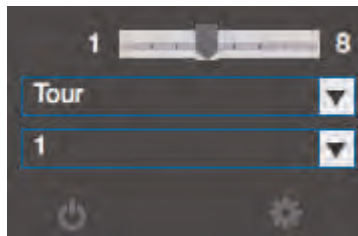

3. Under **Cruise ID**, select the number of the tour you would like to configure.
4. (Optional) Under **Cruise Name**, enter a name for the tour.

- Use the chart to select which presets you would like to include in the tour and the order of presets.

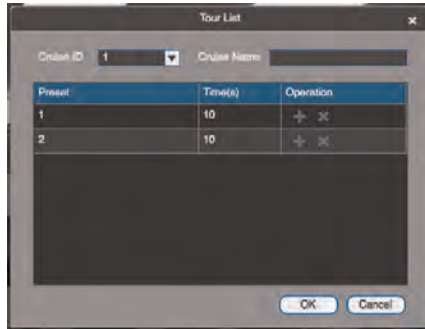

- Preset:** Select the preset number.
- Time(s):** Enter the time in seconds the camera will remain on the selected preset.
- Operation:** Click to add a preset to the tour. Click to delete a preset from the tour.

- Click **OK** to save changes.

To run a PTZ tour:

- Select the tour number and click .

15.3.3 PTZ Pattern

Patterns automatically cycle the camera between two positions.

To create a pattern:

- Click to open the Advanced controls. Select **Pattern**.
- Select the number of the pattern you would like to set up.

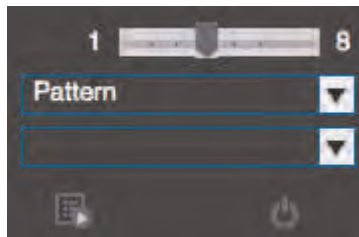

- Move the camera into the desired start position.
- Click to start recording the pattern.
- Move the camera to the desired end position. Then, click to stop recording the pattern.

To run a pattern:

- Select the pattern number and click .



15.3.4 PTZ Scan

Scan automatically cycles between a left and right point.

To set up scan mode:

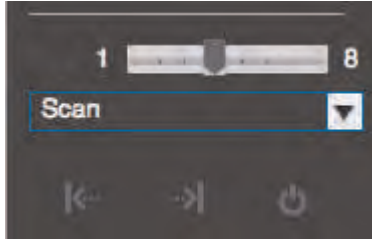
1. Click  to open the Advanced controls. Select **Scan**.



2. Move the camera to the desired left position and click .
3. Move the camera to the desired right position and click .



To run scan mode:

1. Click .

15.3.5 PTZ Pan

Pan makes the camera continuously pan 360°.

To run Pan mode:

1. Click  to open the Advanced controls. Select **Pan**.
2. Click .

15.4 Playback

You can use Playback mode to playback video saved on systems connected to the client.

To access Playback mode:

- Click  and then click  to create a Playback tab.

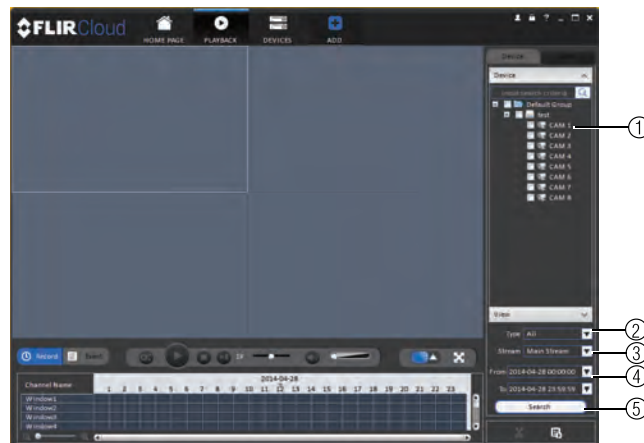

To playback video:

1. Check the channels you would like to play back from in the Device List.
2. Under **Type**, check the file types you would like to search for.
 - **All**: All recordings.
 - **General**: Continuous recordings.
 - **MD**: Motion recordings.
 - **Alarm**: Alarm recordings. Your system must support alarm devices (not included) to use this feature.
3. Under **Stream**, select **Main Stream** to search for Main Stream recordings (high quality) or **Sub Stream** to search for Sub Stream recordings (smaller file size).
4. Select the start time and end time for your search under **From** and **To**. You may not search more than 24 hours of video.
5. Click **Search**. Wait for the client to find video saved to the system.
6. Click inside the play back bar to start playback.





15.5 Playback Controls



1. **Display area:** Double-click to expand/return to split-screen mode. Hold the mouse over the display area to open the camera toolbar.

Main Stream(1730.74 kb/s, 1280*720)

-  **Snapshot:** Click to save a snapshot.
-  **Digital zoom:** Click to enable digital zoom mode. Then, click and drag to zoom in. Click and drag to pan the camera. Click  again to zoom out.

2. **Event:** Click to view recordings based on a list of events and files.
3. **Record:** Click to view recordings on a timeline.
4. **Sync:** Click to sync playback between channels. This forces all channels to playback from the same time.
5. **Pause/play.**
6. **Stop.**
7. **Frame-by-frame:** Click to advance the video by a single frame.
8. **Playback speed:** Use the slider to adjust the playback speed.
9. **Mute.**
10. **Volume.**
11. **Split-screen:** Select split screen configuration.
12. **Full-screen:** Click to open playback in full-screen. Press **ESC** to exit full-screen.
13. **Timeline zoom:** Use the slider to zoom in/out on the timeline.
14. **Playback timeline:** Shows recordings from the selected channels on a timeline. Click inside the timeline to start playback or select a playback time. Each type of recordings is shown in a different color. Continuous recordings are green, motion recordings are yellow, and alarm recordings are red.
15. **Video clip:** Click to start a video clip. You can download video clips to your hard drive.

-
16. **Download list:** Click to see a list of files you have downloaded and the progress of files that are currently downloading.
 17. **Search:** Search for video on the selected channels based on the search parameters you set.
 18. **Device list:** Select the channels you would like to search or playback video from.

15.6 Downloading Video to your Computer Hard Drive



You can download video to your computer hard drive to save important events or share them. It is recommended to download video of important events as soon as possible to ensure they are not overwritten by new recordings.



NOTE

PC Users: You may need to run FLIR Cloud™ Client as an administrator to download files to your hard drive.

To download video files:

1. Start playing back video using the steps in 15.4 *Playback*, page 86.
2. Click  to start a video clip at the current playback time. Click  to stop the video clip.
3. Configure the following save options:

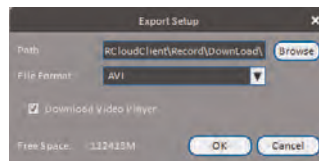

- **Path:** Use the default save folder or click **Browse** to select a different folder.
- **File Format:** Select **Original Format** to save to .dav format (requires the video player). Select **AVI** to save files to .avi format (can be played in VLC Media Player).



NOTE

The Mac version only supports downloading video to .dav format.

- **Download Video Player:** Check to save a copy of the video player with the downloaded file.
4. Click **OK** to start the download. A status screen will pop up to show progress on downloaded files.

NOTE

To retrieve downloaded video files:

- **PC Users:** Browse to the folders listed in **General>File**.
- **Mac Users:** Browse to the folders listed in **General>File**. To get to the default location, open Applications in Finder, right click on **FLIR Cloud Client** and select **Show Package Contents**. Then, navigate to the desired folder.

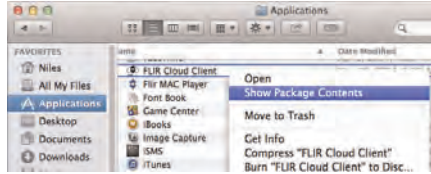

15.7 Alarm

The Alarm menu allows you to view a list of alarms received by the client software.

NOTE

You must set up alarms in the Alarm CFG menu before they will appear in this list. See 15.12 *Alarm CFG*, page 95 for more details.

To access Alarms:

- Click  and then click .

Alarm menu overview:

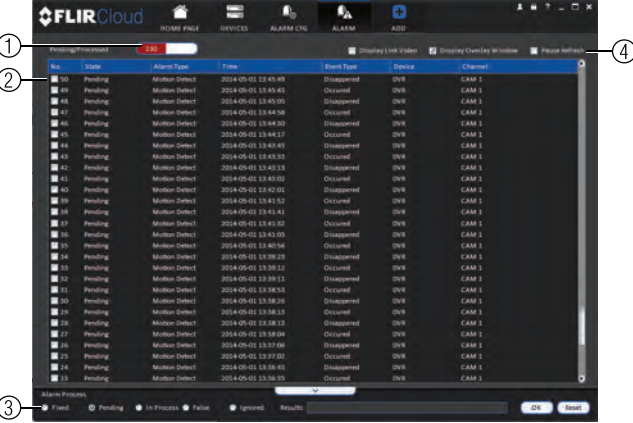

| No. | Status | Alarm Type | Time | Alarm Type | Device | Channel |
|-----|---------|----------------|---------------------|-------------|--------|---------|
| 40 | Pending | Monitor Detect | 2024-05-01 12:45:49 | Disappeared | DNR | CAM 1 |
| 41 | Pending | Monitor Detect | 2024-05-01 12:45:49 | Disappeared | DNR | CAM 1 |
| 42 | Pending | Monitor Detect | 2024-05-01 12:45:49 | Disappeared | DNR | CAM 1 |
| 43 | Pending | Monitor Detect | 2024-05-01 12:44:58 | Disappeared | DNR | CAM 1 |
| 44 | Pending | Monitor Detect | 2024-05-01 12:44:58 | Disappeared | DNR | CAM 1 |
| 45 | Pending | Monitor Detect | 2024-05-01 12:44:58 | Disappeared | DNR | CAM 1 |
| 46 | Pending | Monitor Detect | 2024-05-01 12:44:57 | Disappeared | DNR | CAM 1 |
| 47 | Pending | Monitor Detect | 2024-05-01 12:44:57 | Disappeared | DNR | CAM 1 |
| 48 | Pending | Monitor Detect | 2024-05-01 12:43:45 | Disappeared | DNR | CAM 1 |
| 49 | Pending | Monitor Detect | 2024-05-01 12:43:45 | Disappeared | DNR | CAM 1 |
| 50 | Pending | Monitor Detect | 2024-05-01 12:43:45 | Disappeared | DNR | CAM 1 |
| 51 | Pending | Monitor Detect | 2024-05-01 12:42:01 | Disappeared | DNR | CAM 1 |
| 52 | Pending | Monitor Detect | 2024-05-01 12:41:52 | Disappeared | DNR | CAM 1 |
| 53 | Pending | Monitor Detect | 2024-05-01 12:41:41 | Disappeared | DNR | CAM 1 |
| 54 | Pending | Monitor Detect | 2024-05-01 12:41:32 | Disappeared | DNR | CAM 1 |
| 55 | Pending | Monitor Detect | 2024-05-01 12:41:29 | Disappeared | DNR | CAM 1 |
| 56 | Pending | Monitor Detect | 2024-05-01 12:40:56 | Disappeared | DNR | CAM 1 |
| 57 | Pending | Monitor Detect | 2024-05-01 12:39:23 | Disappeared | DNR | CAM 1 |
| 58 | Pending | Monitor Detect | 2024-05-01 12:39:12 | Disappeared | DNR | CAM 1 |
| 59 | Pending | Monitor Detect | 2024-05-01 12:39:11 | Disappeared | DNR | CAM 1 |
| 60 | Pending | Monitor Detect | 2024-05-01 12:38:53 | Disappeared | DNR | CAM 1 |
| 61 | Pending | Monitor Detect | 2024-05-01 12:38:26 | Disappeared | DNR | CAM 1 |
| 62 | Pending | Monitor Detect | 2024-05-01 12:38:15 | Disappeared | DNR | CAM 1 |
| 63 | Pending | Monitor Detect | 2024-05-01 12:38:04 | Disappeared | DNR | CAM 1 |
| 64 | Pending | Monitor Detect | 2024-05-01 12:37:00 | Disappeared | DNR | CAM 1 |
| 65 | Pending | Monitor Detect | 2024-05-01 12:37:00 | Disappeared | DNR | CAM 1 |
| 66 | Pending | Monitor Detect | 2024-05-01 12:36:45 | Disappeared | DNR | CAM 1 |
| 67 | Pending | Monitor Detect | 2024-05-01 12:36:25 | Disappeared | DNR | CAM 1 |

1. **Number of alarms:** Shows the number of open alarms.
2. **Alarm list:** Shows the list of alarms and information on when they occurred and which systems and channels triggered them.
3. **Alarm Process:** You can close alarms by selecting one of the options and clicking **OK**.

4. **Options:** Check to enable the following:

- **Display Link Video:** Open live video to monitor alarms on a continuous basis.
- **Display Overlay Window:** Show the overlay controls. They allow you to enable/disable sound alerts and quickly jump back to the Alarm menu from another tab.



- **Pause Refresh:** Stop refreshing the live video in the video popup.

15.8 Log

The Log menu allows you to view logs for the client software or to view logs for connected systems.

To access logs:

- Click  and then click .

To view client logs:

1. Click **Client Log** to view logs for the client software.

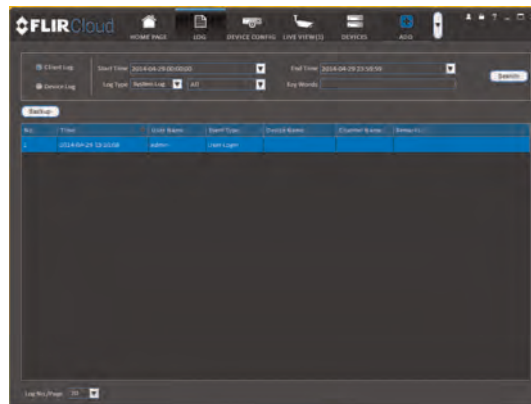

2. Configure the following:

- **Start Time/End Time:** Select the start and end times to search for logs.
- **Log Type:** Select the type of logs to search for.

3. Click **Search**.

To view logs from connected systems:

1. Click **Device Log** to view logs from connected systems.

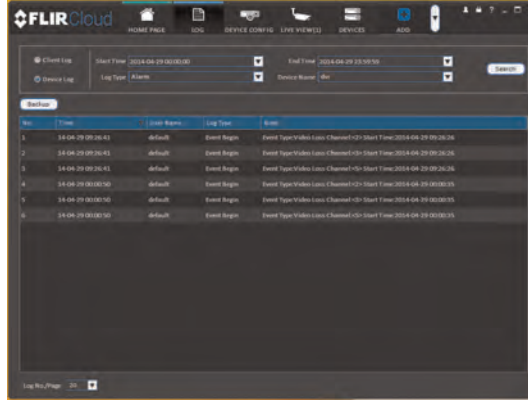



2. Configure the following:
 - **Start Time/End Time:** Select the start and end times to search for logs.
 - **Log Type:** Select the type of logs to search for.
 - **Device Name:** Select the system you would like to view logs from.
3. Click **Search**.

15.9 E-map

E-Map allows you to place cameras over a still image. For example, you can use the E-Map to create a virtual map of your cameras over a floor plan of your home or business.

To create an E-map:

1. Click  and then click .
2. Click **Add Map**.



3. Configure the following:

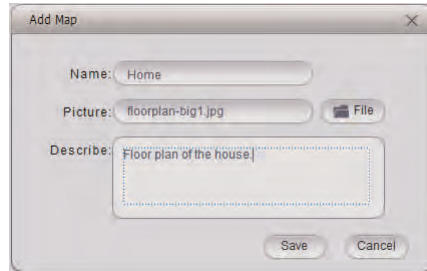

- **Name:** Enter a name for your e-map of your choice.
 - **Picture:** Click **File** and then select a .png, .bmp, or .jpg image on your computer to use as the e-map.
 - **Describe (optional):** Enter a text description of the e-map.
4. Click **Save**.
 5. Click **Edit** to edit the e-map.



6. Click and drag cameras from the device list to place them on the map.

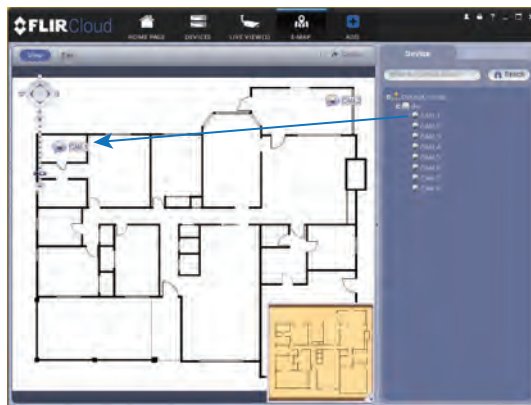

To open cameras from the e-map:

1. Click **View**.

2. Double-click cameras on the map to open live video.



15.10 Devices

The Devices menu is where you can manage systems connected to the client software.

To access the Devices menu:

- Click  and then click .

Devices overview:

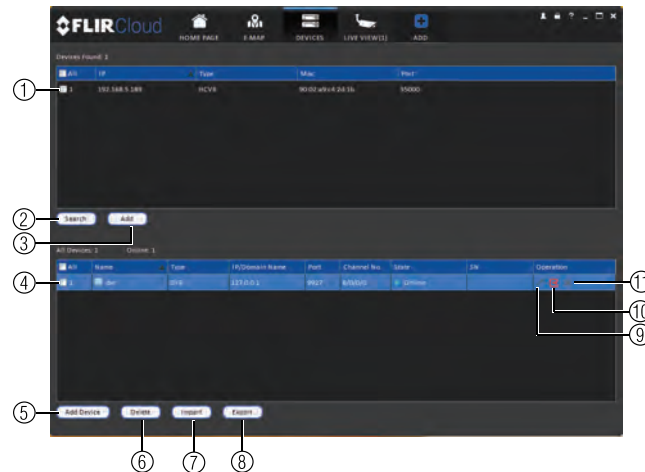



1. **Devices Found:** Shows systems that are connected to the same network as the computer where the client is installed. Once you connect to the system, it moves to the bottom of the screen.
2. **Search:** Refresh the list of systems connected to the network.
3. **Add:** Add checked systems to the client software.
4. **Device list:** Shows a list of systems connected to the client software, and shows which systems are online.
5. **Add Device:** Add a remote system using a Device ID or IP/DDNS address.
6. **Delete:** Delete the selected system.
7. **Import:** Import a list of systems from a saved .xml file.
8. **Export:** Export a list of currently connected systems to an .xml file. This is useful if you need to re-install the software or if you want to open the same list of systems on a different computer.
9. **Delete:** Delete system.
10. **Manual connect/disconnect:** Manually connect/disconnect the system.

11. **Edit:** Edit the connection details for the system.

15.11 Device Config

The Device Config menu allows you to remotely configure settings for connected systems.

To access the Device Config menu:

- Click  and then click .
- Click on a system in the device list to see the settings available for that system and then configure settings as needed.

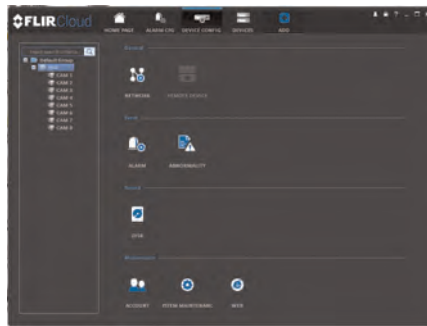

NOTE

The settings available depend on the model of system you have.

15.12 Alarm CFG



The Alarm CFG menu allows you to configure alarms for the client software. The client software will alert you by popping up live video and playing sound alerts.



NOTE

Alarm upload must be enabled on the system in order for it to send the alarm to the client software.

To create alarms:

1. Click  and then click .
2. Click **Add** to create a new alarm.

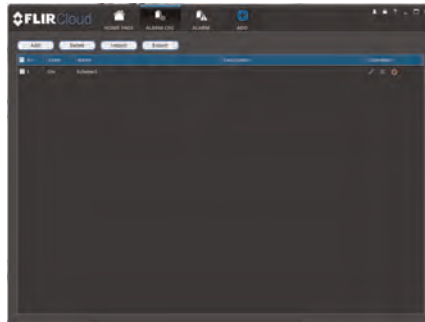

3. In the **Alarm sources** menu, you set up the parameters that trigger the alarm.

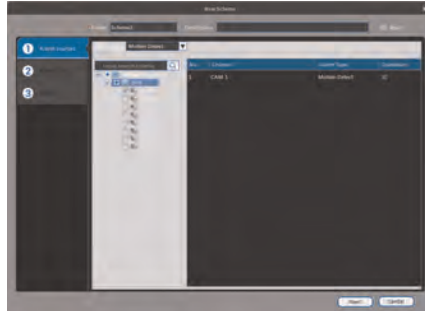

- Under **Alarm Type**, select the alarm type that will trigger an alarm. For example, you can select Motion Detect for the alarm to be triggered by motion.
- Select the systems or channels you would like to trigger an alarm. Continuing the example, if CAM 1 is selected, the alarm will be triggered if there is motion on CAM 1.
- Click **Next**.

4. In the **Alarm link** menu, you set up the responses to alarms. Select the channels that will pop up or alarm out devices (not included; not all systems support alarm out devices) that will be triggered by an alarm.
For each channel selected, configure the following:

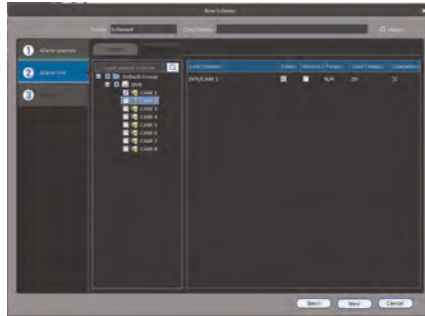

- **Video:** Pop up a window with live video from the selected channel, like the one below.



- **Record:** Record video from the selected channel.

**NOTE**

PC Users: You may need to run the client software as admin to record.

- **Preset:** If you select a PTZ camera, you can select the preset that will be activated when an alarm occurs.
 - **Stay Time:** Enter how many seconds the video window will stay open or record when an alarm occurs.
5. Click **Next**.
6. In the **Period** window, configure times the alarm will be activated.

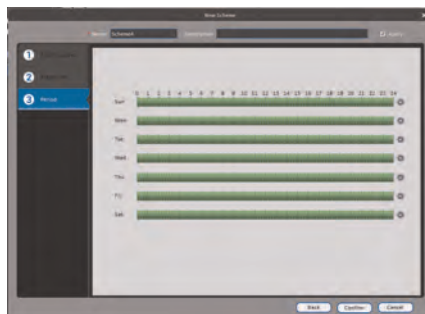

7. Click **Confirm** to save the alarm.

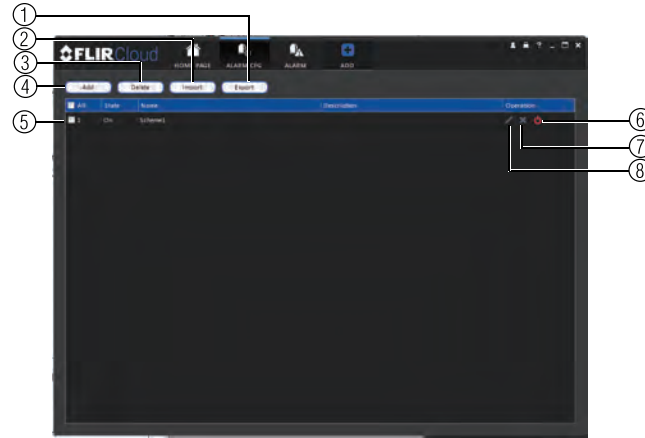
To manage alarms:

1. **Export:** Export current list of alarms as an xml file.
2. **Import:** Import list of alarms.
3. **Delete:** Delete selected alarm.
4. **Add:** Add new alarm.
5. **Alarms.**
6. **On/off:** Click to enable/disable alarm.
7. **Delete:** Click to delete alarm.
8. **Edit:** Click to edit alarm settings.



15.13 Tour & Task

The Tour & Task menu is where you can set up custom views for the system. You can also set up tours, which sets the client to automatically cycle through views.

To start a tour:

- Click  in Live View to start a tour. The live view will automatically cycle through all views you have set up in the Tour & Task menu. Click again to stop the tour.

To add views:

1. Click  and then click .
2. Click **+** to create a new view.

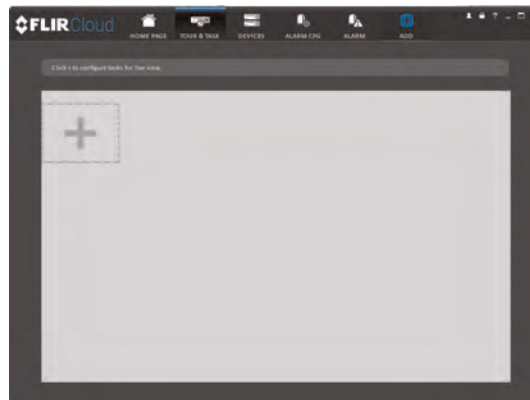

3. Under **Name**, enter a name for your view.
4. Under **Stay Time**, enter the number of seconds the view will be shown before the client switches to the next view.
5. Select the split-screen mode you would like to use for the view and then click and drag channels to the empty grid areas to select channels to be shown in the view.

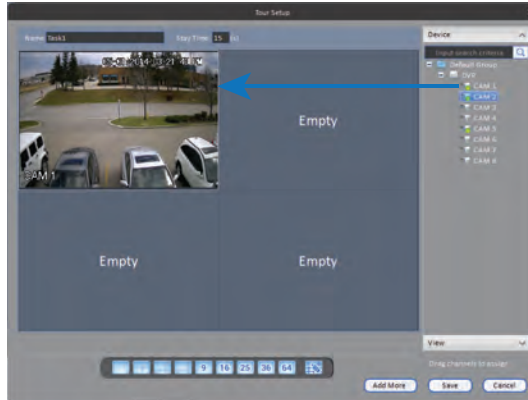

6. Click **Save** to save the view. Or click **Add More** to save the view and create another view.

15.14 Account

The Account menu is where you can set up user accounts and passwords for the client software. To simplify management, you can group user accounts according to role. A role determines the permissions an individual user account can have.

To access the account menu:

- Click  and then click .

15.14.1 Managing User Accounts

By default, the client software includes an admin account that has full access to all features of the software and all connected systems. You can add user accounts with customized levels of access.



NOTE

The admin account cannot be deleted. The default user name for the admin account is **admin** and the default password is **admin**.

To create a user account:

1. Click **Add**.

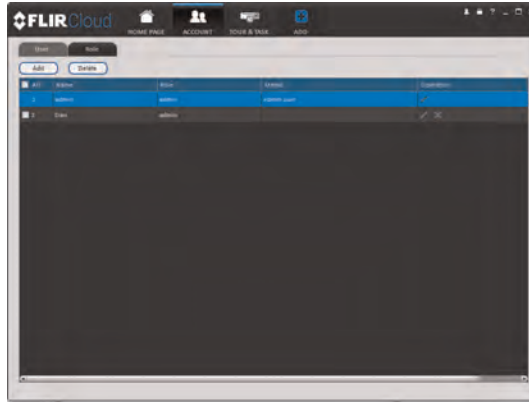

2. Configure the following settings for the user account:

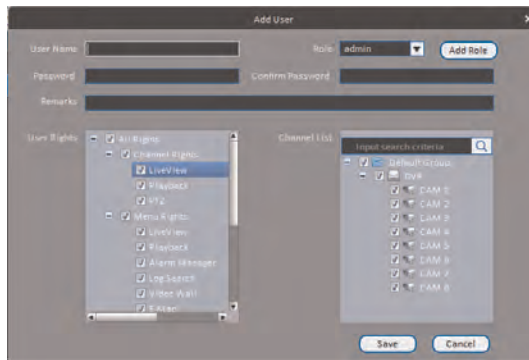

- **User Name:** Enter a user name for the account.
- **Role:** Select the role for the user account. By default, the user account gains all the permissions of the role selected, but you can deactivate permissions as needed.
- **Password/Confirm Password:** Enter the password for the user account.
- **Remarks (Optional):** Enter a text description of the user account.
- **User Rights:** Check the permissions that will apply to the user account. If you click on LiveView, Playback, and PTZ, you can select which channels the user account can access in the Channel List section.

3. Click **Save** to create the account.

To switch between user accounts:

- Click .

To modify a user account:**NOTE**

Admin accounts with Account Setup permissions can change account passwords. A user cannot change his own password.

- Click  next to the user account you would like to modify. Edit the user account details and click **Save**.

To delete a user account:

1. Click  next to the user account you would like to delete. Click **OK** to confirm.

15.14.2 Managing Roles

Roles make it easier to manage user accounts by determining the permissions an individual user account can have. By default, a new user account is given all the permissions of the role they are assigned to.

To create a role:

1. Click the **Role** tab.
2. Click **Add**.

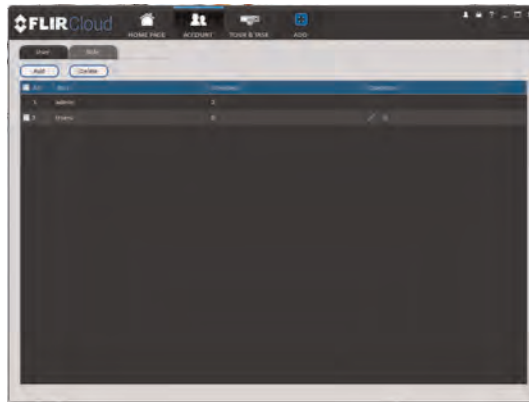

3. Configure the following settings for the role:

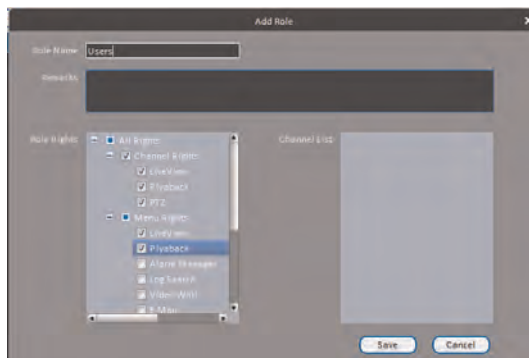

- **Role Name:** Enter a name for the role.
- **Remarks (Optional):** Enter a text description of the role.
- **Role Rights:** Check the permissions that will apply to user accounts assigned this role. If you click on LiveView, Playback, and PTZ, you can select which channels may be accessed in the Channel List section.

4. Click **Save**.

To modify a role:

- Click  next to the role you would like to modify. Edit the role details and click **Save**.

To delete a user account:

1. Click  next to the role you would like to delete. Click **OK** to confirm.

15.15 General

The General menu is where you can configure application settings for the client software.

To access the General menu:

- Click  and then click .

15.15.1 Basic

The Basic menu contains general settings for the client software.

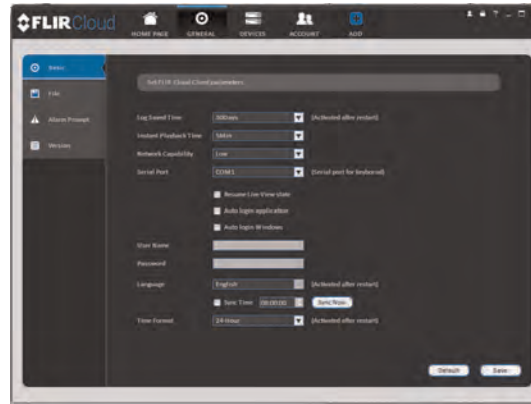

The Basic menu contains the following settings:

- **Log Saved Time:** Select the number of days you would like the client to save log entries.
- **Instant Playback Time:** Select the number of minutes the system will go back when you start an instant playback.
- **Network Capability:** Select the speed of your computer's network connection.
- **Resume Live View State:** Check for the client to resume live view when it starts up. The live view will open to the last view that you had open.
- **Auto login application:** Check for the client to automatically login when it starts up without entering a user name or password.
- **Auto Login Windows:** Not supported.
- **Language:** Select the language for the client software.
- **Sync Time:** Check to have the client software sync time with your computer's system time. Select the time the software will sync the time. Click **Sync Now** to manually sync the time.
- **Time Format:** Select **12-Hour** or **24-Hour** time format. You must close the client and restart it to apply this setting.



NOTE

Click **Save** to save setting changes.

15.15.2 File

The File menu allows you to select the folders where the client software will save downloaded video files and snapshots.

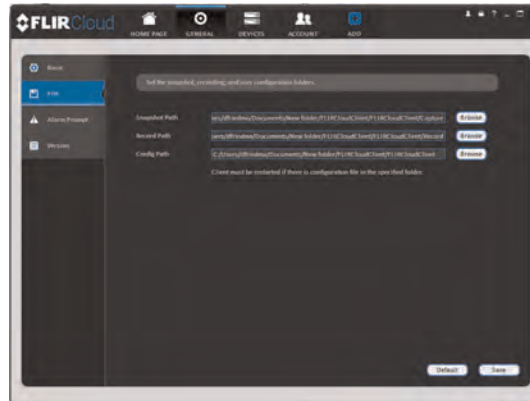

The File menu contains the following options:

- **Snapshot Path:** Click **Browse** to select the default folder to save snapshots.
- **Record Path:** Click **Browse** to select the default folder to save video recordings.
- **Config Path:** Click **Browse** to select the folder where the client will save software config files.

| |
|--|
|  NOTE |
| Click Save to save setting changes. |
| PC Users: You may need to run the client software as admin to save files to enable snapshot or video recording. |

15.15.3 Alarm Prompt

The Alarm Prompt menu allows you to configure audio alerts. The client will play audio alerts when events occur. You can replace the default sounds with any .wav file.

| |
|---|
|  NOTE |
| You must configure alarms in the Alarm CFG menu before the client will play alarm sounds. |

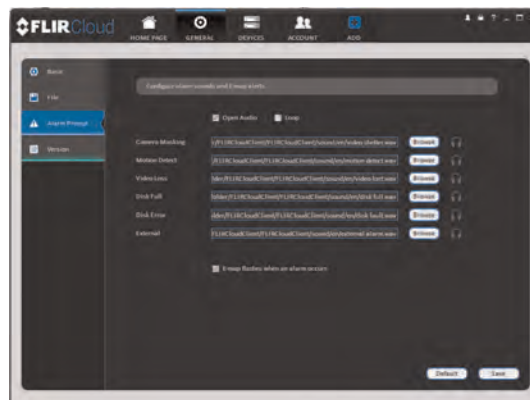

The Alarm Prompt menu has the following options:

- **Open Audio:** Check to enable audio alerts.
- **Loop:** Check to repeat audio alerts until acknowledged.
- **Camera Masking:** Select or preview the sound that will play for camera masking alarms.

-
- **Motion Detect:** Select or preview the sound that will play for motion detection.
 - **Video Loss:** Select or preview the sound that will play for video loss alarms.
 - **Disk Full:** Select or preview the sound that will play for disk full alarms.
 - **Disk Error:** Select or preview the sound that will play for disk errors.
 - **External:** Select or preview the sound that will play for external alarms (triggered by sensor devices, which may not be supported on all systems).
 - **E-map flashes when alarm occurs:** If the camera has alarms enabled and is added to an e-map, a  appears on the e-map when an event occurs.

**NOTE**

Click **Save** to save changes.

15.15.4 Version

The Version menu shows you which version of the client software you are using. It is recommended to always run the latest version of the software from www.lorextechnology.com/support.

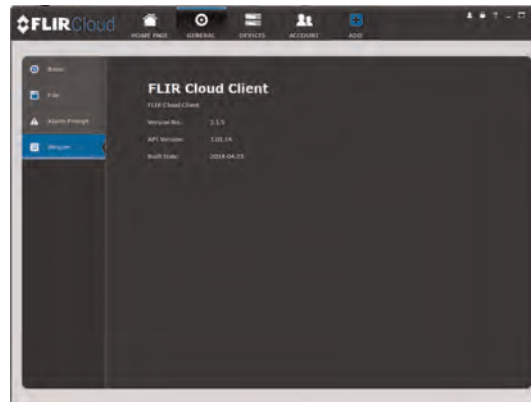

Connecting to your System Using Smartphone or Tablet Apps

The system is compatible with iPhone, iPad and Android devices.

| Platform | App Name | Get App From |
|-------------|-------------|-------------------|
| iPhone/iPad | FLIR Cloud™ | Apple App Store |
| Android | FLIR Cloud™ | Google Play Store |

See www.lorextechnology.com/support for the latest list of supported apps and devices.

16.1 iPhone

FLIR Cloud™ is an iPhone app that allows you to remotely view your system.

16.1.1 Prerequisites

- Connect your system to your router using an Ethernet cable (included).
- **Make sure to upgrade your system to the latest firmware version.** You must have the latest firmware and mobile apps to connect to the system over the Internet.



NOTE



For the latest list of supported apps and devices, visit www.lorextechnology.com/support.



NOTE

The app will ask for permission to send push notifications and to access Photos. It will only send notifications if you enable motion-activated push notifications in the Push Config menu. It needs access to Photos to save snapshots and video clips to the local storage on your mobile device.

16.1.2 Connecting to your System on iPhone

1. Download **FLIR Cloud™** for free from the App Store.
2. Tap on the FLIR Cloud™ icon () to start the app.
3. Tap **Sign up** and enter your email address and password to create a new account.
4. Tap  then .



5. Configure the following:

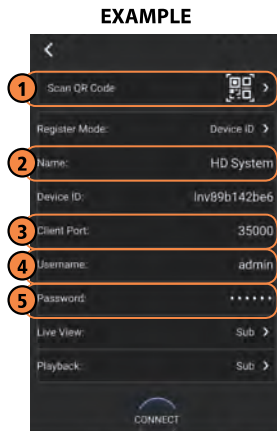

- 5.1. Tap **Scan QR Code** and line up the QR code on the top of your system using the camera on your mobile device.



OR

Under **Device ID**, manually enter the Device ID printed on the label.

- 5.2. **Name:** Choose a name for your system of your choice.
 - 5.3. **Client Port:** Enter the **Client Port** (default: **35000**).
 - 5.4. **User Name:** Enter the **system's User Name** (default: **admin**).
 - 5.5. **Password:** Enter the **system's Password** (default: **000000**).
6. Tap **Connect**. You will be prompted to change the system password.
 7. Enter a new 6 character password and tap **OK**. This password will be used to log on to your system from now on.
 8. The app opens in Live View and streams video from your cameras.

16.1.3 Live View Interface

You can use FLIR Cloud™ in portrait and landscape mode.

Live View Overview

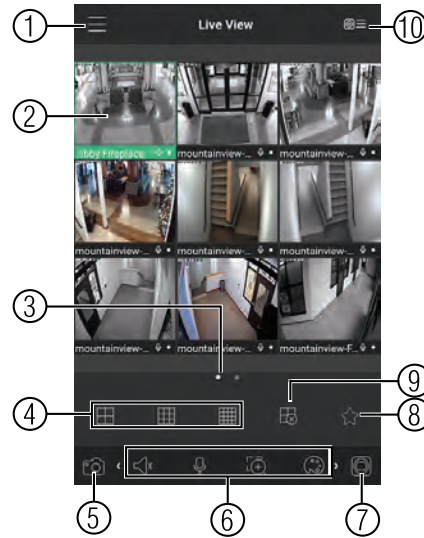

1. **Menu:** Tap to bring up the Menu.
2. **Display Area:** Double-tap to open a channel in full screen. Swipe left or right to select a different page of channels.
3. **Pages:** Shows the number of pages available and highlights the currently selected page.
4. **Split:** Select the split-screen layout.
5. **Snapshot:** Tap to take a snapshot from the currently selected channel.
6. **Control Bar:** Contains the following options. Swipe left or right to access more options.

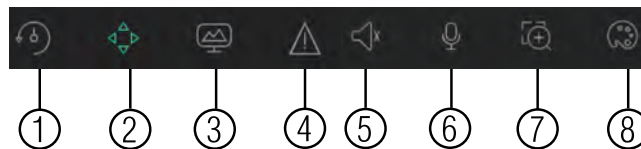

- 6.1. **Quick Playback:** Tap to start/stop quick playback.
- 6.2. **PTZ Controls:** Open/close PTZ controls. PTZ camera required (not included).
- 6.3. **Streaming Quality:** Open/close streaming quality panel.
- 6.4. **Not supported.**
- 6.5. **Not supported.**
- 6.6. **Not supported.**
- 6.7. **Digital Zoom:** Tap to activate digital zoom mode. Pinch to zoom in/out.
- 6.8. **Color Settings:** Tap to access color controls for the currently selected camera.
7. **Manual record:** Tap to start/stop manual recording.
8. **Access Favorites.**
9. **Connect/disconnect all:** Connect to/disconnect from all previously added cameras.
10. **Device List:** Tap to open a list of devices. You can use the Device List to open multiple systems or cameras at once.

16.1.4 Controlling PTZ Cameras

If you have PTZ cameras (not included), you can control them from the app.

To control PTZ cameras:

1. Tap the display area the PTZ camera is connected to.

2. Tap  to open PTZ controls.

PTZ Controls

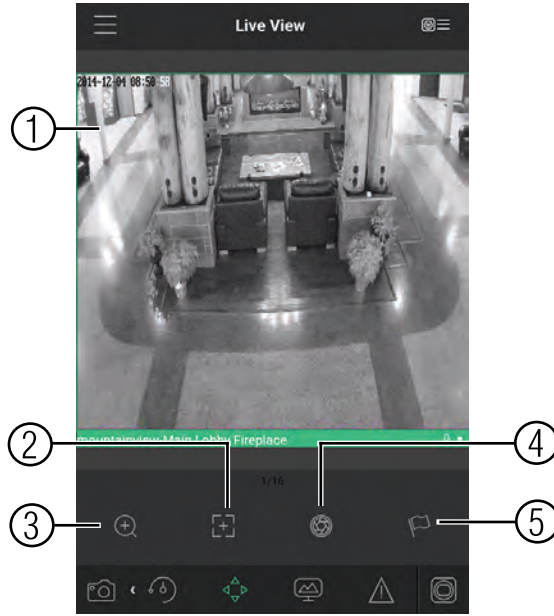

1. **Live Display:** Swipe to move the camera. Pinch to zoom in/out.
2. **Focus:** Tap to show focus controls.
3. **Zoom:** Tap to show zoom controls.
4. **Iris:** Tap to show iris controls.
5. **Goto preset:** Tap to access preset controls. Then use the sliders to select a preset and then tap the checkmark to goto the preset.



NOTE

You must set presets for the camera using the system's local menus before you can use this feature.

16.1.5 Viewing Snapshots and Videos with Local Files

If you have saved snapshots or videos using the app, you may open them with Local Files.

To access Local Files:

- Tap  to access the Menu, and then tap **Local Files**.

Local Files Overview



1. **Menu:** Return to Menu.
2. **Files:** Tap to open files.
3. **File Type:** Tap the options to select video files or snapshots.
4. **Options:** Tap to delete or export files to your device's local storage.

 **NOTE**
 Exported snapshots and video files are saved to the Photos app. Video files are saved to MP4 format.

16.1.6 Using Playback Mode on iPhone

You can access recorded video on your system using your iPhone.

 **NOTE**
 You must enable Sub Stream Recording to use playback mode on mobile devices.

To use Playback Mode:

1. Tap  to access the Menu, and then tap **Playback**.
2. Tap **+** and select a channel to playback.

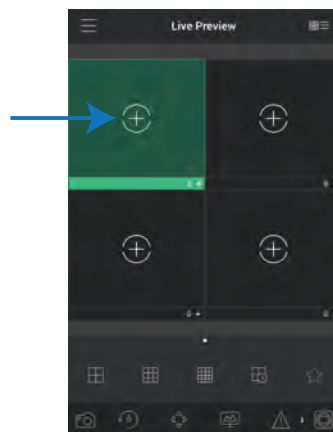

3. Select the date then the start and end times to playback.
4. Use the on-screen controls to control playback.

Playback Controls

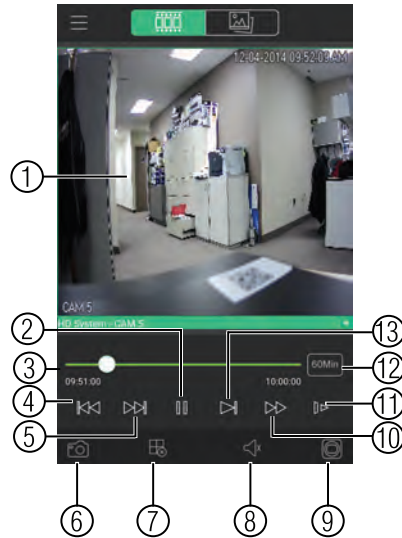

- 4.1. **Display Area:** Double-tap to open in full-screen.
- 4.2. **Play/pause.**
- 4.3. **Time Bar:** Tap inside the bar to fast forward or rewind.
- 4.4. **Previous:** Select previous video file.
- 4.5. **Next:** Select next video file.
- 4.6. **Snapshot:** Tap to take a snapshot from the selected camera.
- 4.7. **Stop All:** Stop playback on all channels.
- 4.8. **Not supported.**
- 4.9. **Manual Record:** Tap to start/stop recording to your mobile device's local storage.
- 4.10. **Fast.**
- 4.11. **Slow.**
- 4.12. **Time Range:** Tap to change the range of time shown in the time bar.
- 4.13. **Next frame.**

16.1.7 Enabling Push Notifications

You can have the app send push notifications to the notifications area on your device when one of your cameras detects motion. Once you have received a push notification, you can select it to open live video or a snapshot attachment from the camera that detected motion.

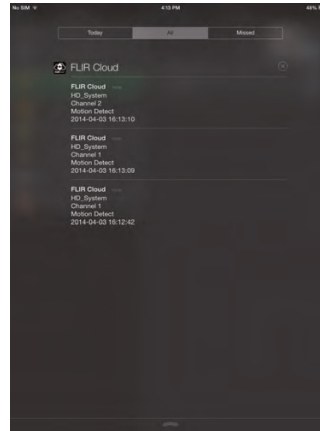
**NOTE**

Your cameras must have motion detection activated to receive push notifications.

To enable Push Notifications:

1. Tap  to access the Menu, and then tap **Push Config**.
2. Tap the system you would like to configure.

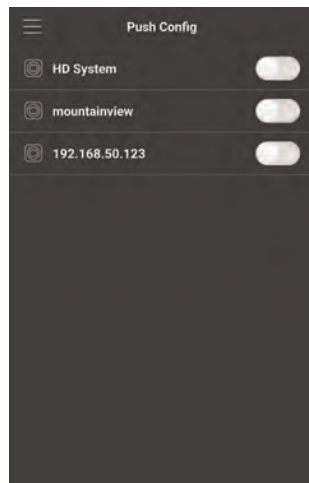

3. Tap **Motion Detect** and then check each channel you would like to receive push notifications from.

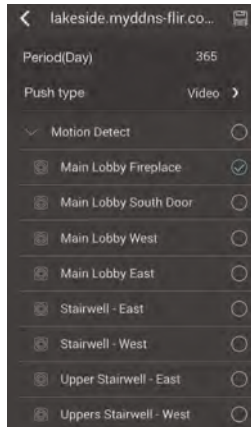

4. Tap  to save changes. You will now receive a notification when one of the selected cameras detect motion.

16.1.8 Using the Event List

The Event List menu shows a list of events that were sent to your device via push notifications.

NOTE

You must configure push notifications before you can use the Event List.

To access the Event List:

- Tap  to access the Menu, and then tap **Event List**.

Event List Overview

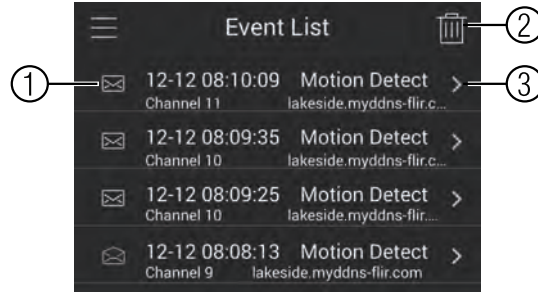

1. **Events:** Shows the details of each motion detection event. Tap the event to view the video or snapshot.
2. **Delete All:** Tap to delete all events in the Event List.

NOTE

To delete a single event, swipe it to the left and then tap **Delete**.

The inset screenshot shows the 'Event List' with a red 'Delete' button overlaid on the left side of the bottom-most event entry.

3. **View:** Tap to view the video or snapshot for the selected event.

16.1.9 Using Favorites

Favorites allows you to select a group of cameras as a favorite. You can then quickly bring up the group of cameras in Live View without having to individually select each camera.

To use Favorites:

1. Tap to access the Menu, and then tap **Favorites**.
2. Tap a group to configure an existing group.

NOTE

Tap to create a new group and then enter a name for the new group.

3. To add cameras to the group, tap .

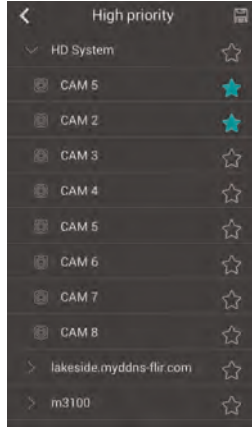

4. Select the cameras you would like to add to the group. Tap  to save changes.



 **NOTE**

To delete cameras that have been added to the group, select the group in the group list. Then, swipe left and tap **Delete**.

To open Favorites in Live View:

1. Tap  to access the Menu, and then tap **Live View**.
2. Tap , and then tap  to open the group.

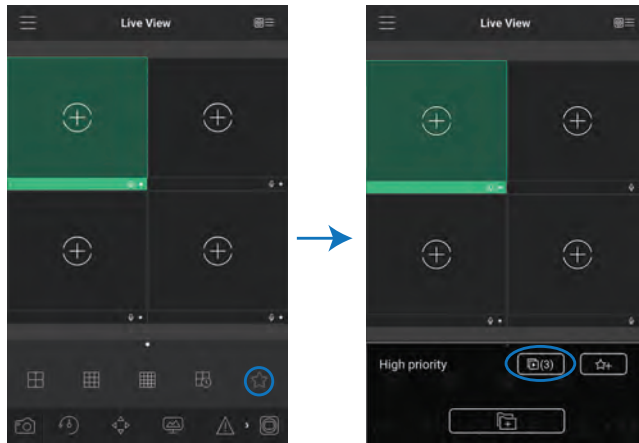

16.1.10 Using the E-Map

E-Map allows you to place cameras over a still image. For example, you can use the E-Map to create a virtual map of your cameras over a floor plan of your home or business.

To add an E-Map:

1. Tap  to access the Menu, and then tap **E-Map**.

2. Tap .

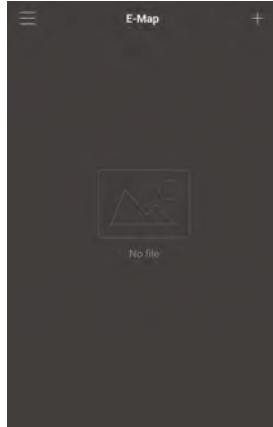

3. Select a .jpg image on your mobile device.
4. Press  and select a camera. Drag the camera on the screen to place it on the map. Repeat to add additional cameras.



5. Click . Choose a name for your E-Map and then tap **OK**.

To open cameras from an E-Map:

1. Tap  in Live View.

2. Select the E-Map in the Device List.

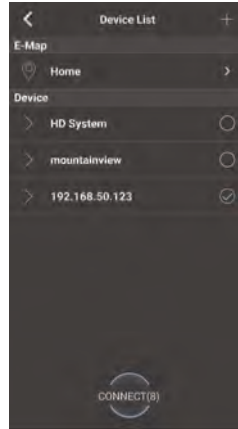

3. Tap the camera or cameras to select and then tap **Connect** to open the cameras.



16.1.11 Device Manager

You can use Device List to add, delete, or edit your systems.

To access Device Manager:

- Tap  to access the Menu, and then tap **Device Manager**.

To edit a system:

1. Tap the system in Device Manager. Tap .

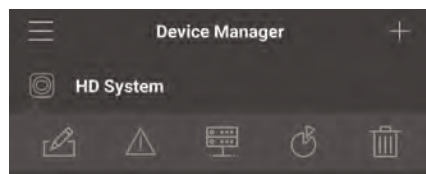

2. Edit the connection details as needed.
3. Tap **Connect** to save changes and connect to the system.

To delete a system:

1. Tap the system you would like to delete.
2. Tap . Tap **OK** to confirm.

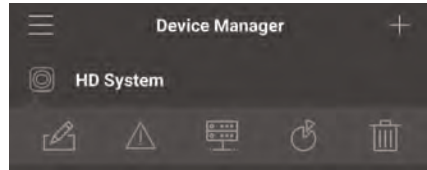
**16.1.12 Adding Devices Using an IP or DDNS Address (Advanced)**

The app can connect directly to a device via the IP address or DDNS address as an optional advanced connectivity method or for systems that do not support FLIR Cloud™.

Prerequisites:

- The device you are connecting to must be connected to the Internet.
- You must port forward the HTTP Port (default: **80**) and Client port (**35000**) on your router to the device's local IP address.
- To ensure connectivity, it is highly recommended to register for a free DDNS domain to use with your system.
- For more information on port forwarding and DDNS, visit www.lorextechnology.com/support.

To add a device using an IP or DDNS address:

1. Tap  then .



2. Configure the following:



- 2.1. Tap **Register Mode** and select **IP/Domain**.
- 2.2. **Name:** Choose a name for your system of your choice.
- 2.3. **Address:** Enter the IP address or DDNS address of your system.
- 2.4. **Client Port:** Enter the **Client Port** (default: **35000**).
- 2.5. **User Name:** Enter the **system's User Name** (default: **admin**).

- 2.6. **Password:** Enter the **system's Password** (default: **000000**).
3. Tap **Connect**. You will be prompted to change the system password.
4. Enter a new 6 character password and tap **OK**. This password will be used to log on to your system from now on.
5. The app opens in Live View and streams video from your cameras.

16.2 iPad

FLIR Cloud™ is an iPad app that allows you to remotely view your system.

16.2.1 Prerequisites

- Connect your system to your router using an Ethernet cable (included).
- **Make sure to upgrade your system to the latest firmware version.** You must have the latest firmware and mobile apps to connect to the system over the Internet.



NOTE



For the latest list of supported apps and devices, visit www.lorexttechnology.com/support.



NOTE

The app will ask for permission to send push notifications and to access Photos. It will only send notifications if you enable motion-activated push notifications in the Push Config menu. It needs access to Photos to save snapshots and video flips to the local storage on your mobile device.

16.2.2 Connecting to your system on an iPad

1. Install FLIR Cloud™ for free from the App Store.
2. Tap on the FLIR Cloud™ icon () to start the app.
3. Tap  then .
4. Tap **Device Manager**.
5. Tap **Add**.

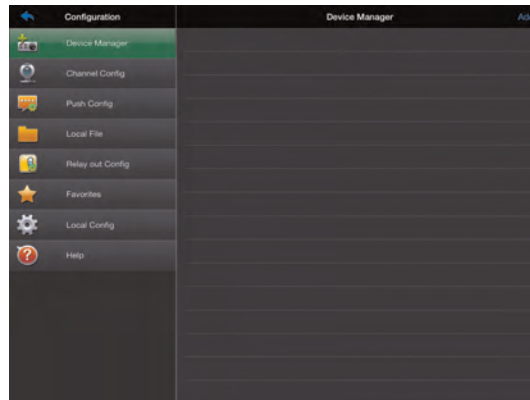

6. Configure the following:

EXAMPLE

- 6.1. Tap **Start Scanning** and line up the QR code on the top of the system using the camera on your device.

**OR**

Under **Device ID**, manually enter the Device ID printed on the label.

- 6.2. **Name:** Choose a name for your system of your choice.
- 6.3. **Client Port:** Enter the Client Port (default: **35000**).
- 6.4. **User Name:** Enter the system's User Name (default: **admin**).
- 6.5. **Password:** Enter the system's Password (default: **000000**)
- 6.6. **Channel Amount:** Enter the number of channels your system has.
7. Tap **Start Live View**. You will be prompted to change the system password.
8. Enter a new 6 character password and tap **OK**. This password will be used to log on to your system from now on.
9. The app opens in Live View and streams video from all connected cameras.

16.2.3 Live View Interface

You can use FLIR Cloud™ in landscape or portrait mode.

Live View Overview

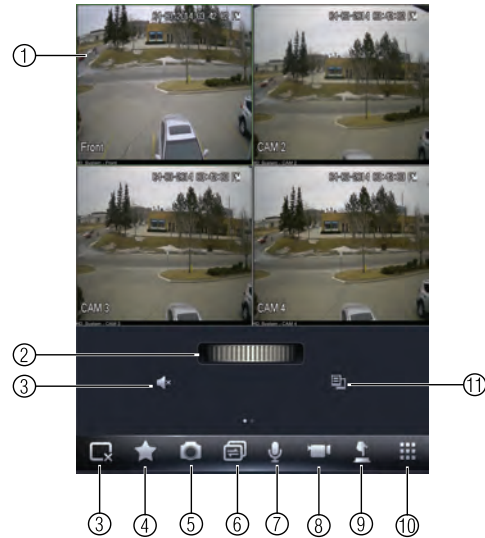

1. **Display area:** Double-tap to open camera in full screen.
2. **Favorites:** Slide to select favorites.
3. **Disconnect:** Disconnect from all open cameras.
4. **Add to favorites:** Add the current view to favorites.
5. **Snapshot:** Tap to take a snapshot from the currently selected channel.



NOTE

You can view or share snapshots using the Photos app.

6. **Change display view.**
7. **Not supported.**
8. **Manual record:** Tap to start/stop manual recording from this channel.
9. **Not supported.**
10. **Open menus.**
11. **Select different camera.**

16.2.4 Controlling PTZ Cameras

If you have PTZ cameras (not included), you can control them using the app.

To control PTZ cameras:

1. In Live View, tap the window the PTZ camera is connected to.

- Slide the middle controls to the right to access PTZ controls.

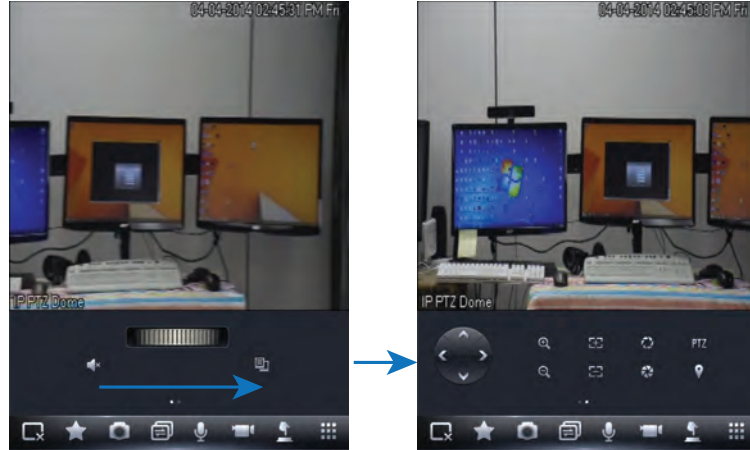

PTZ Controls

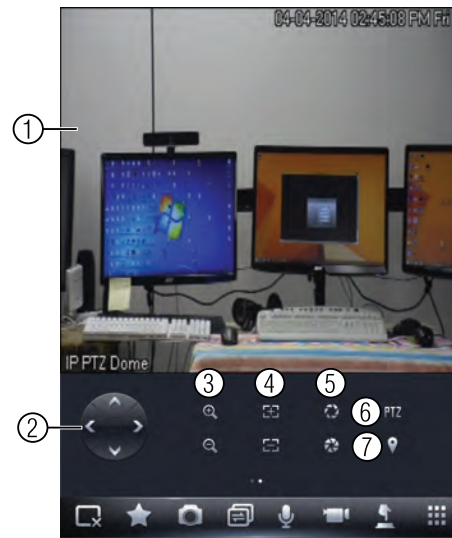

- Live display:** Swipe to move the camera. Pinch to zoom in/out.
- Direction buttons:** Tap to move the camera.
- Zoom:** Tap to zoom the camera in/out.
- Focus:** Tap +/- to adjust the focus.
- Iris:** Tap +/- to adjust the iris.
- PTZ/EPTZ:** Tap to switch between PTZ and EPTZ mode. Use PTZ mode to control PTZ cameras. Use EPTZ mode to activate digital zoom mode on non-PTZ cameras.
- Goto preset:** Tap to goto a camera preset.



NOTE

You must set presets for the camera using the system's local menus before you can use this feature.



16.2.5 Using Playback Mode on iPad

You can access recorded video on your system using your iPad.

**NOTE**

You must enable Substream Recording to use playback mode on mobile devices.

To use Playback Mode:

1. From Live View tap  then .
2. In Portrait Mode: Tap +, select the start time and end time for your search, and select the camera you would like to playback.

OR

In Landscape Mode: Select the start time and end time for your search, and drag the camera you would like to playback to the display area.

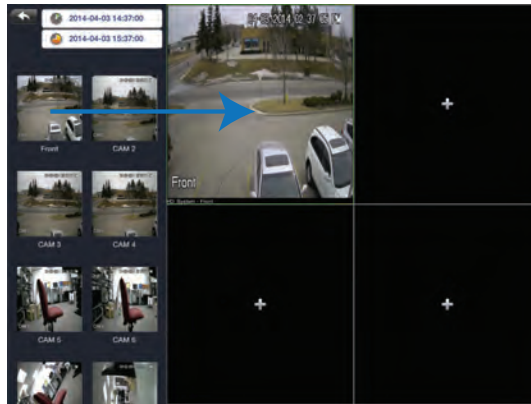

3. Use the playback controls.

Playback Controls

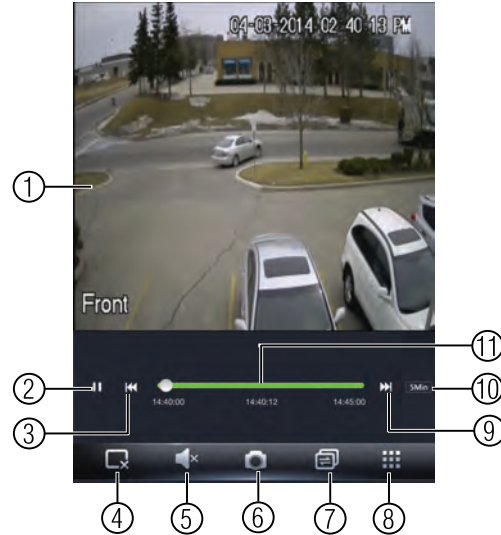

1. **Display area:** Double-tap to open camera in full screen.
2. **Play/pause.**
3. **Previous file.**
4. **Disconnect:** Disconnect from the currently selected camera.
5. **Not supported.**
6. **Snapshot:** Tap to take a snapshot from the currently selected camera.
7. **Change display view.**
8. **Menu.**
9. **Next file.**
10. **Time range:** Tap to change the range of time shown in the time bar.
11. **Time Bar:** Tap inside the bar to fast forward or rewind.



NOTE

Playback controls are only shown in portrait mode.

16.2.6 Using Local File to View Manual Recordings

You can view manual recordings saved to your mobile device using the Local File menu.

To view manual recordings:

1. From live view, tap then .
2. Tap **Local Files**.

3. Tap a video file to open it.

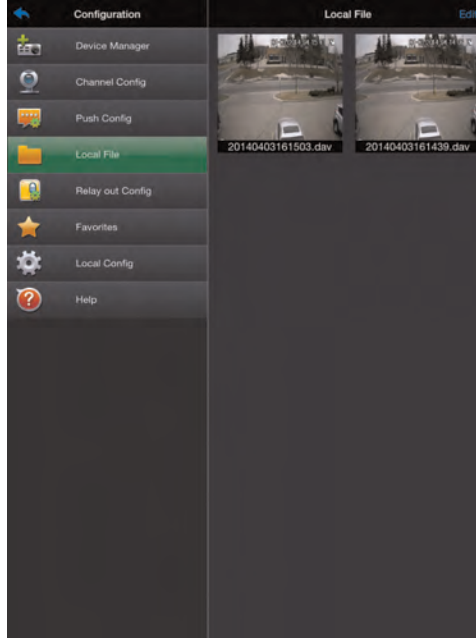

To delete videos:

1. Tap **Edit**.
2. Select the videos you would like to delete and tap .

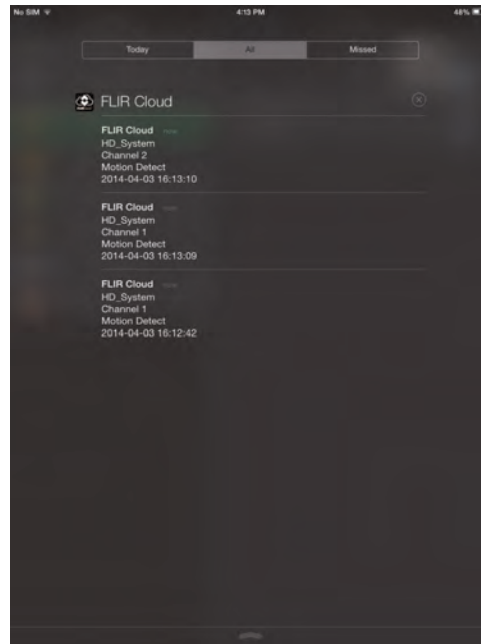

16.2.7 Enabling Push Notifications

You can have the app send push notifications to the notifications area on your device when one of your cameras detects motion. Once you have received a push notification, you can select it to open video or an image from the camera that detected motion.

**NOTE**

Your cameras must have motion detection activated to receive push notifications.

To enable Push Notifications:

1. From live view, tap  then .
2. Tap **Push Config**.
3. Tap the slider for the system you would like to configure.

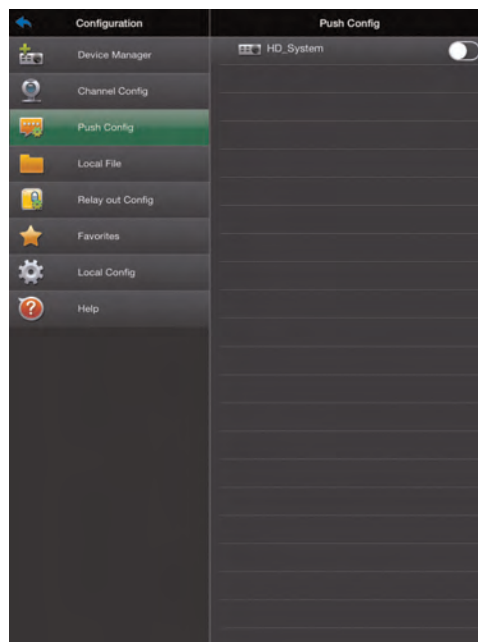

4. Tap **Motion Detect** then check each channel you would like to receive push notifications from.





5. Under **Type**, select Playback to attach a video file with each push notification. Or, select **Picture** to attach a still image of the camera that detected motion.
6. Tap **OK** to save changes. Whenever the selected cameras detect motion, you will receive a notification.

16.2.8 Using the Event List

The Event List menu shows a list of events that were sent to your device via push notifications.

| |
|---|
|  NOTE |
| You must configure push notifications before you can use the Event List. |

To access the Event List:

1. From live view, tap  then .

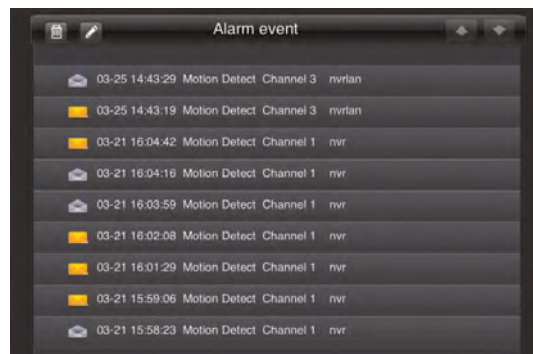

16.2.9 Using Favorites

Favorites allows you to select a group of cameras as a favorite. You can then quickly bring up the group of cameras in Live View without having to individually select each camera.

To create favorites:



1. In Live View, tap  to save the cameras that are currently open as a favorite.
2. Enter a name for the favorite and tap **OK**.

To open favorites in Live View:

- In Live View, slide the dial to cycle through favorites.



To edit favorites:

1. From live view, tap  then .
2. Tap **Favorites**.
3. Tap the favorite you would like to edit.





4. Tap **Edit**.
5. Select the cameras you would like to include in the favorite and then tap **Save**.

16.2.10 Using the E-Map

E-Map allows you to place cameras over a still image. For example, you can use the E-Map to create a virtual map of your cameras over a floor plan of your home or business.

To add an E-Map:

1. From live view, tap  then .
2. Tap **Add**.

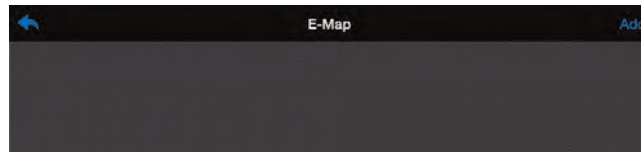

3. Select a .jpg image file on your mobile device.



4. To edit the E-map:



- 4.1. **Select Image:** Select a different image file to use for your E-Map.
- 4.2. **Add Camera:** Tap + to select cameras to add to your E-Map. Then drag the camera to place it on the E-Map.
- 4.3. **Delete E-Map.**
5. When you are finished editing the E-Map, tap **Save** and enter a name for the E-Map to save changes.

To open cameras using the E-Map:

1. In live view, tap + on an empty display window and select the E-Map.





2. Tap a camera from the E-map to open.



16.2.11 Using the Device Manager

Device Manager allows you to manage your systems.

To access Device Manager:

1. From live view, tap  then .
2. Tap **Device Manager**.

To delete a system:

1. Tap the system to select it.
2. Tap . Tap **Yes** to confirm.



To modify a system:

1. Tap a system to select.
2. Tap the system again to open the edit screen.
3. Update the connection details as needed and then tap **Start Live View**.

16.2.12 Adding Devices Using an IP or DDNS Address (Advanced)



The app can connect directly to a device via the IP address or DDNS address as an optional advanced connectivity method or for systems that do not support FLIR Cloud™.

Prerequisites:

- The device you are connecting to must be connected to the Internet.

- You must port forward the HTTP Port (default: **80**) and Client port (default: **35000**) on your router to the device's local IP address.
- To ensure connectivity, it is highly recommended to register for a free DDNS domain to use with your system.
- For more information on port forwarding and DDNS, visit www.lorextechnology.com/support.

To add a device using an IP or DDNS address:

1. Install FLIR Cloud™ for free from the App Store.
2. Tap on the FLIR Cloud™ icon () to start the app.
3. Tap  then .
4. Tap **Device Manager**.
5. Tap **Add**.



6. Configure the following:

EXAMPLE

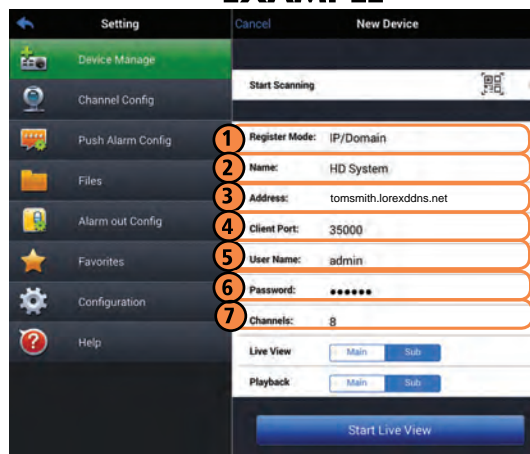

- 6.1. Tap **Register Mode** and select **IP/Domain**. Then tap **New Device** to return to the New Device screen.
- 6.2. **Name**: Choose a name for your system of your choice.
- 6.3. **Address**: Enter the DDNS or IP address of your device.
- 6.4. **Client Port**: Enter the Client Port (default: **35000**).
- 6.5. **User Name**: Enter the system's User Name (default: **admin**).

- 6.6. **Password:** Enter the system's Password (default: **000000**)
- 6.7. **Channel Amount:** Enter the number of channels your system has.
7. Tap **Start Live View**. You will be prompted to change the system password.
8. Enter a new **6 character password** and tap **OK**. This password will be used to log on to your system from now on.
9. The app opens in Live View and streams video from all connected cameras.

16.3 Android

FLIR Cloud™ allows you to remotely view your system on Android devices.

16.3.1 Prerequisites



- Connect your system to your router using an Ethernet cable (included).
- **Make sure to upgrade your system to the latest firmware version.** You must have the latest firmware and mobile apps to connect to the system over the Internet.



NOTE

For the latest list of supported apps and devices, visit www.lorextechnology.com/support.

16.3.2 Connecting to your System on Android

1. Download **FLIR Cloud™** for free from the Google Play Store.
2. Tap on the FLIR Cloud™ icon () to start the app.
3. Tap **Sign up** and enter your email address and password to create a new account.
4. Tap  then .



5. Configure the following:

EXAMPLE



- 5.1. Tap **Scan QR Code** and line up the QR code on the top of your system using the camera on your mobile device.



OR

Under **Device ID**, manually enter the Device ID printed on the label.

- 5.2. **Name:** Choose a name for your system of your choice.
 - 5.3. **Client Port:** Enter the **Client Port** (default: **35000**).
 - 5.4. **User Name:** Enter the **system's Username** (default: **admin**).
 - 5.5. **Password:** Enter the **system's Password** (default: **000000**).
6. Tap **Connect**. You will be prompted to change the system password.
 7. Enter a new 6 character password and tap **OK**. This password will be used to log on to your system from now on.

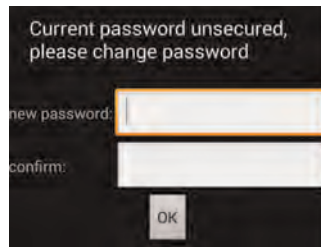

8. The app opens in Live View and streams video from your cameras.

16.3.3 Live View Interface

You can use FLIR Cloud™ in portrait and landscape mode.

Live View Overview

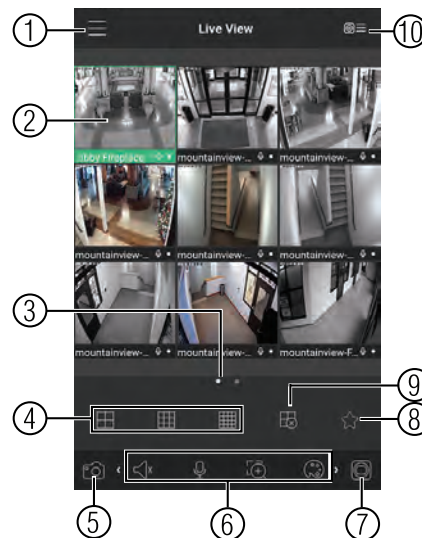

1. **Menu:** Tap to bring up the Menu.
2. **Display Area:** Double-tap to open a channel in full screen. Swipe left or right to select a different page of channels.
3. **Pages:** Shows the number of pages available and highlights the currently selected page.
4. **Split:** Select the split-screen layout.
5. **Snapshot:** Tap to take a snapshot from the currently selected channel.
6. **Control Bar:** Contains the following options. Swipe left or right to access more options.

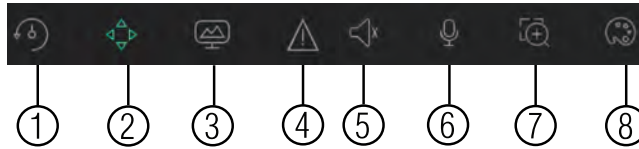

- 6.1. **Quick Playback:** Tap to start/stop quick playback.
 - 6.2. **PTZ Controls:** Open/close PTZ controls. PTZ camera required (not included).
 - 6.3. **Streaming Quality:** Open/close streaming quality panel.
 - 6.4. **Not supported.**
 - 6.5. **Not supported.**
 - 6.6. **Not supported.**
 - 6.7. **Digital Zoom:** Tap to activate digital zoom mode. Pinch to zoom in/out.
 - 6.8. **Color Settings:** Tap to access color controls for the currently selected camera.
- 7. **Manual record:** Tap to start/stop manual recording.
 - 8. **Access Favorites.**
 - 9. **Connect/disconnect all:** Connect to/disconnect from all previously added cameras.
 - 10. **Device List:** Tap to open a list of devices. You can use the Device List to open multiple systems or cameras at once.

16.3.4 Controlling PTZ Cameras

If you have PTZ cameras (not included), you can control them from the app.

To control PTZ cameras:

- 1. Tap the display area the PTZ camera is connected to.
- 2. Tap  to open PTZ controls.

PTZ Controls

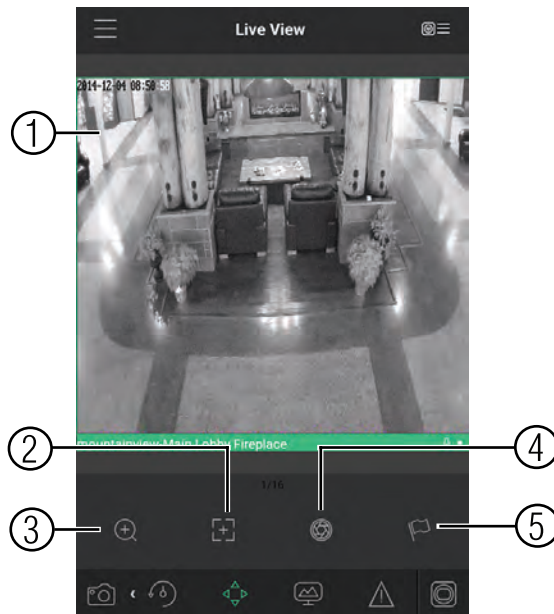

- 1. **Live Display:** Swipe to move the camera. Pinch to zoom in/out.
- 2. **Focus:** Tap to show focus controls.
- 3. **Zoom:** Tap to show zoom controls.

4. **Iris:** Tap to show iris controls.
5. **Goto preset:** Tap to access preset controls. Then use the sliders to select a preset and then tap the checkmark to goto the preset.

| |
|---|
|  NOTE |
| You must set presets for the camera using the system's local menus before you can use this feature. |

16.3.5 Viewing Snapshots and Videos with Local Files

If you have saved snapshots or videos using the app, you may open them with Local Files.

To access Local Files:

- Tap  to access the Menu, and then tap **Local Files**.

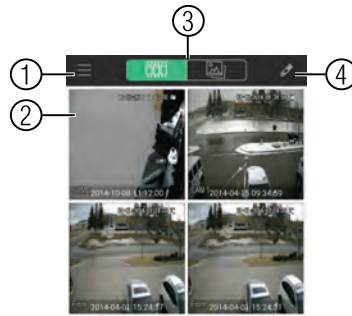

1. **Menu:** Return to Menu.
2. **Files:** Tap to open files.
3. **File Type:** Tap the options to select video files or snapshots.
4. **Options:** Tap to share, delete, or export files to your device's local storage.

| |
|--|
|  NOTE |
| Exported video files are saved to MP4 format in the folder <code>/snapshot/mp4/</code> , which you can access by connecting your Android device to a computer using a USB cable. |

16.3.6 Using Playback Mode on Android

You can access recorded video on your system using your Android.

| |
|---|
|  NOTE |
| You must enable Sub Stream Recording to use playback mode on mobile devices. For details on enabling Sub Stream Recording, see 9.3 <i>Setting up Scheduled or Manual Recording</i> , page 25. |

To use Playback Mode:

1. Tap  to access the Menu, and then tap **Playback**.

2. Tap + and select a channel to playback.

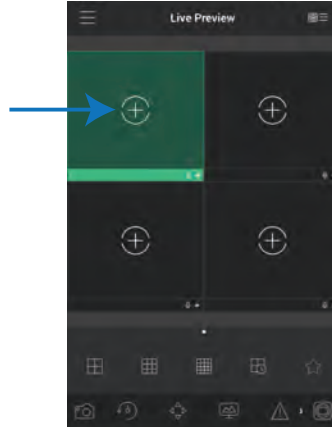

3. Select the date then the start and end times to playback.
4. Use the on-screen controls to control playback.

Playback Controls

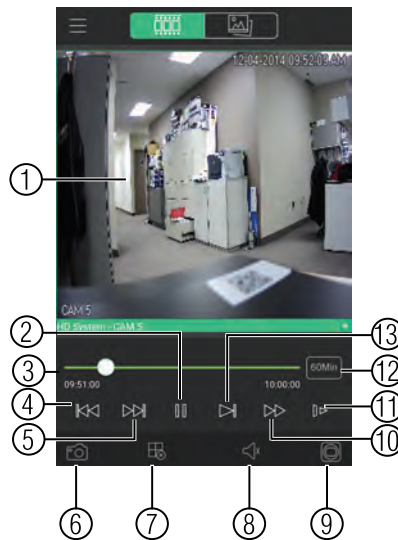

- 4.1. **Display Area:** Double-tap to open in full-screen.
- 4.2. **Play/pause.**
- 4.3. **Time Bar:** Tap inside the bar to fast forward or rewind.
- 4.4. **Previous:** Select previous video file.
- 4.5. **Next:** Select next video file.
- 4.6. **Snapshot:** Tap to take a snapshot from the selected camera.
- 4.7. **Stop All:** Stop playback on all channels.
- 4.8. **Not supported.**
- 4.9. **Manual Record:** Tap to start/stop recording to your mobile device's local storage.
- 4.10. **Fast.**
- 4.11. **Slow.**
- 4.12. **Time Range:** Tap to change the range of time shown in the time bar.
- 4.13. **Next frame.**

16.3.7 Enabling Push Notifications

You can have the app send push notifications to the notifications area on your device when one of your cameras detects motion. Once you have received a push notification, you can select it to open live video or a snapshot attachment from the camera that detected motion.

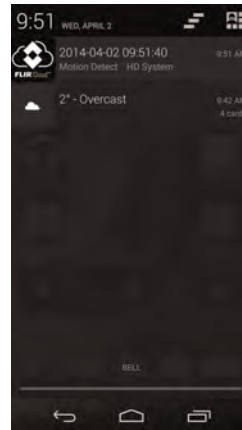

NOTE

Your cameras must have motion detection activated to receive push notifications.

To enable Push Notifications:

1. Tap  to access the Menu, and then tap **Push Config**.
2. Tap the system you would like to configure.

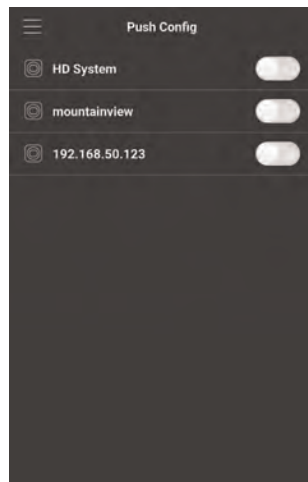

3. Tap **Motion Detect** and then check each channel you would like to receive push notifications from.

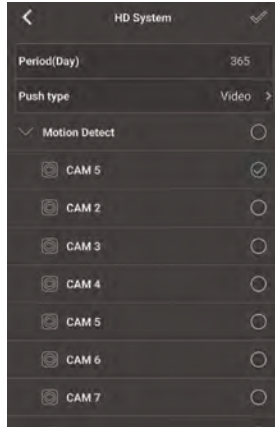

4. Under **Push type**, select **Video** to attach a video clip to each push notification. Or, select **Image** to attach an image to each push notification.
5. Tap  to save changes. You will now receive a notification when one of the selected cameras detect motion.

16.3.8 Using the Event List

The Event List menu shows a list of events that were sent to your device via push notifications.



NOTE

You must configure push notifications before you can use the Event List.

To access the Event List:

- Tap  to access the Menu, and then tap **Event List**.

Event List Overview

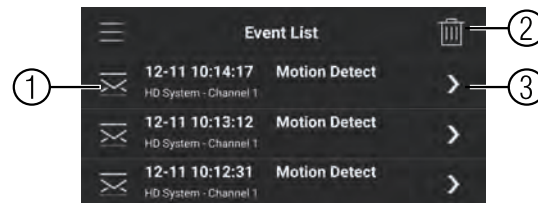



1. **Events:** Shows the details of each motion detection event. Long press an event to delete just that event.
2. **Delete All:** Tap to delete all events in the Event List.
3. **View:** Tap to view the video or snapshot for the selected event.

16.3.9 Using Favorites



Favorites allows you to select a group of cameras as a favorite. You can then quickly bring up the group of cameras in Live View without having to individually select each camera.

To use Favorites:

1. Tap  to access the Menu, and then tap **Favorites**.
2. Tap a group to configure an existing group.

 **NOTE**

Tap  to create a new group and then enter a name for the new group.

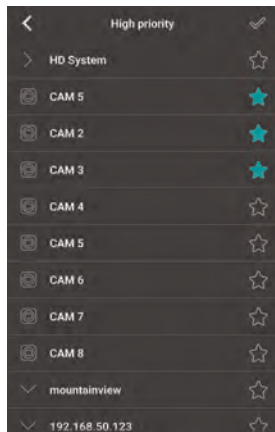

3. To add cameras to the group, tap .
4. Select the cameras you would like to add to the group. Tap  to save changes.



 **NOTE**

To delete cameras that have been added to the group, select the group in the group list. Then, press and hold to delete cameras from the group.

To open Favorites in Live View:

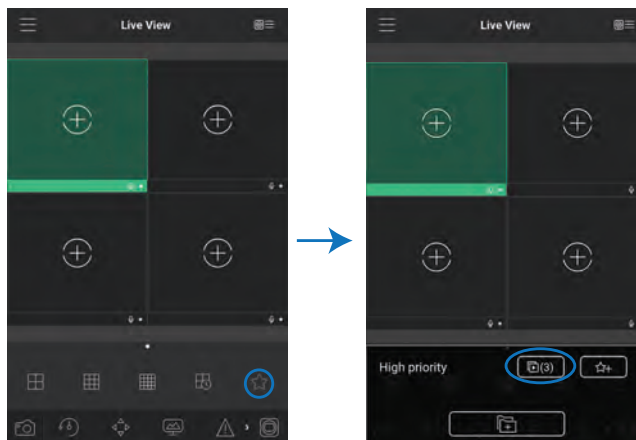

1. Tap  to access the Menu, and then tap **Live View**.
2. Tap , and then tap  to open the group.



16.3.10 Using the E-Map

E-Map allows you to place cameras over a still image. For example, you can use the E-Map to create a virtual map of your cameras over a floor plan of your home or business.

To add an E-Map:

1. Tap  to access the Menu, and then tap **E-Map**.
2. Tap .



3. Select a .jpg image on your mobile device.
4. Press  and select a camera. Drag the camera on the screen to place it on the map. Repeat to add additional cameras.



5. Click . Choose a name for your E-Map and then tap **OK**.

To open cameras from an E-Map:

1. Tap  in Live View.

2. Select the E-Map in the Device List.

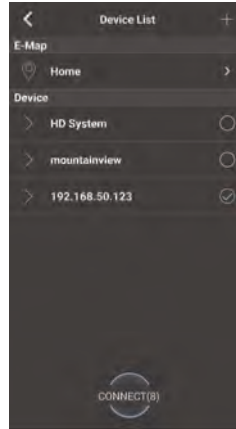

3. Tap the camera or cameras to select and then tap **Connect** to open the cameras.



16.3.11 Device Manager

You can use Device List to add, delete, or edit your systems.

To access Device Manager:

- Tap  to access the Menu, and then tap **Device Manager**.

To edit a system:

1. Tap the system in Device Manager. Tap .

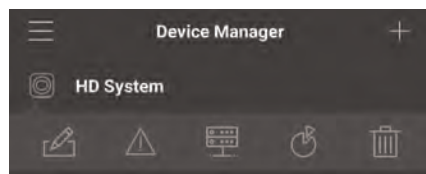

2. Edit the connection details as needed.
3. Tap **Connect** to save changes and connect to the system.

To delete a system:

1. Tap the system you would like to delete.
2. Tap . Tap **OK** to confirm.

**16.3.12 Adding Devices Using an IP or DDNS Address (Advanced)**

The app can connect directly to a device via the IP address or DDNS address as an optional advanced connectivity method or for systems that do not support FLIR Cloud™.

Prerequisites:

- The device you are connecting to must be connected to the Internet.
- You must port forward the HTTP Port (default: **80**) and Client port (default: **35000**) on your router to the device's local IP address.
- To ensure connectivity, it is highly recommended to register for a free DDNS domain to use with your system.
- For more information on port forwarding and DDNS, visit www.lorextechnology.com/support.

To add a device using an IP or DDNS address:

1. Tap  then .



2. Configure the following:



- 2.1. Tap **Register Mode** and select **IP/Domain**.
- 2.2. **Name:** Choose a name for your system of your choice.
- 2.3. **Address:** Enter the IP address or DDNS address of your device.
- 2.4. **Client Port:** Enter the **Client Port** (default: **35000**).
- 2.5. **Username:** Enter the **system's User Name** (default: **admin**).

- 2.6. **Password:** Enter the **system's Password** (default: **000000**).
3. Tap **Connect**. You will be prompted to change the system password.
4. Enter a new 6 character password and tap **OK**. This password will be used to log on to your system from now on.

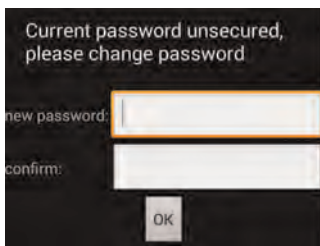

5. The app opens in Live View and streams video from your cameras.

Free DDNS service is available as an optional connectivity method to connect to your system over the Internet.

DDNS Service is not required to connect to your system, since the system supports FLIR Cloud™. For details on setting up your system using FLIR Cloud™, see 14 *Connecting to Your System Over the Internet on PC or Mac*, page 74.



NOTE

Except where noted, the instructions in this section are the same on PC or Mac.

17.1 Accessing your System within a Local Network (LAN)

You can connect to your system through using the Client Software through the local area network (LAN). It is recommended to confirm connectivity over a local network before setting up your system for DDNS connectivity.



NOTE

To complete the steps below, your computer must be on the same network as your system.

17.1.1 Step 1 of 3: Connect your System to Your Router

1. Power off your system by disconnecting the power adapter.
2. Connect an Ethernet cable (included) to the **LAN** port on the rear panel of the system. Connect the other end of the Ethernet cable to an empty LAN port (usually numbered 1~4) on your router.

3. Reconnect the power adapter to power the system back on.

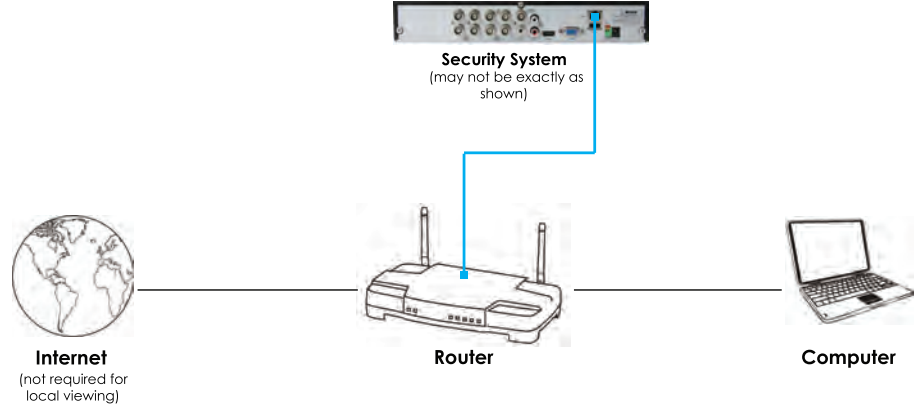

17.1.2 Step 2 of 3: Obtain the System's Local IP Address

1. Right-click to open the Quick Menu and click **Info**. Enter the system user name (default: **admin**) and password (default: **000000**).



2. Write down the **IP Address** of the system.
 - A local IP looks something like this: 192.168.5.118.

17.1.3 Step 3 of 3: Connect to the System's Local IP Address

Follow the steps below to confirm connectivity over a local network on a PC or Mac.

To connect using the system's local IP address:

1. Download and install the client software.
 - **PC Users:** Download and install the **Client Software for PC** from www.lorextechnology.com/support.
 - **Mac Users:** Download and install the **Client Software for Mac** from www.lorextechnology.com/support. Double click to extract the software. Drag the software to **Applications**.
2. Once installation is finished, double-click the FLIR Cloud™ Client icon (📁) from the desktop or Applications list.

- Log into the Client Software using the Client Software user name (default: **admin**) and password (default: **admin**) and then click **Login**.

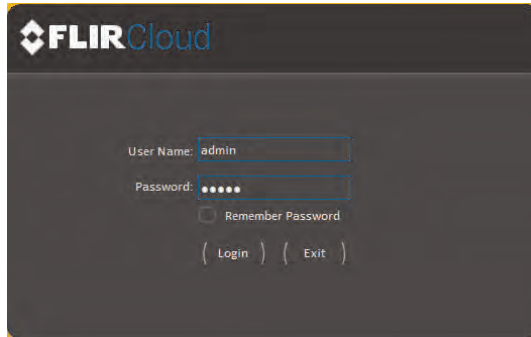

- The client scans your LAN for connected systems. Check your system (a) and click **Add** (b).

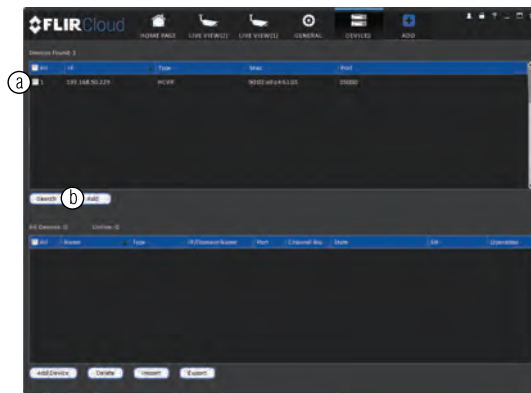

- Enter the password for your system (default: **000000**) and click **OK**.
- If this is the first time you are connecting, you will be prompted to change the system password.

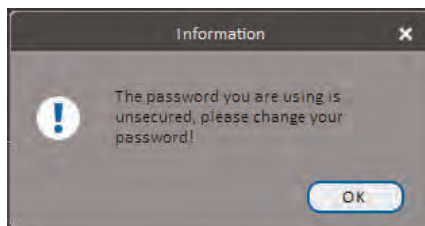

7. Enter a new 6 character password and click **OK**. This password will be used to connect to your system from now on.

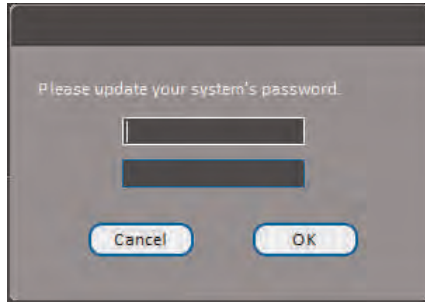

8. Click  then .
9. Click and drag **Default Group** to the display window to open your cameras in live view.

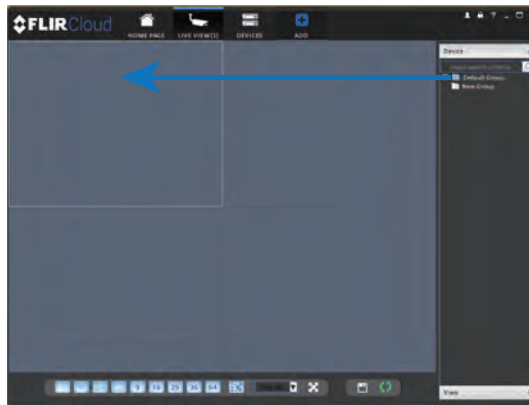

Result



17.2 DDNS Setup—Access your System Remotely over the Internet

Setting up DDNS connectivity allows you to view your system from any computer or compatible mobile device with Internet access.

To set up remote connectivity with your system, you must:

1. Port forward the HTTP port (default: **80**) and Client port (default: **35000**) on your router to your system's IP address.
2. Create a DDNS account.
3. Enable DDNS on the system.
4. Test the remote connection by entering your DDNS address in the client software.

17.2.1 Step 1 of 4: Port Forwarding

You **must** port forward the HTTP port (default: **80**) and Client port (default: **35000**) on your router to your system's IP address before you can remotely connect to your system. There are several methods to port forward your router:

- Use the **Auto Port Forwarding Wizard** (PC only) to port forward the required ports (see www.lorextechnology.com for details). For instructions, see the Auto Port Forward Wizard manual on www.lorextechnology.com.
- Manually port forward the required ports on your router to your system's IP address by following your router manufacturer's instructions. For more information on port forwarding, see the reference guides on www.lorextechnology.com.



NOTE

If the above ports are not forwarded on your router, you will not be able to access your system remotely.

17.2.2 Step 2 of 4: Create a DDNS Account

Lorex offers a free DDNS service for use with your system. A DDNS account allows you to set up a web site address that points back to your local network. This allows you to connect to your system remotely. You must create a DDNS account in the same network as your system.

To setup your free Lorex DDNS account:

1. In your browser, go to <http://www.lorexddns.net> and click **Step 1**.



2. The My Lorex account login screen opens (if you are already logged in, skip to step 4). Create a new account or log into an existing account. To create a new account, fill in the required fields on the right and click **Create Account**.

3. Click **Warranties** to register your product for warranty.



| | |
|---|-------------|
|  | NOTE |
| Warranty registration is required to register for DDNS. | |

4. The Warranty page opens. Click **Activate Warranty** to register your product for warranty.
5. Under **Your Address**, select an address or click **Enter a New Address** to create a new address. Fill in your address information and click **Create Address**.

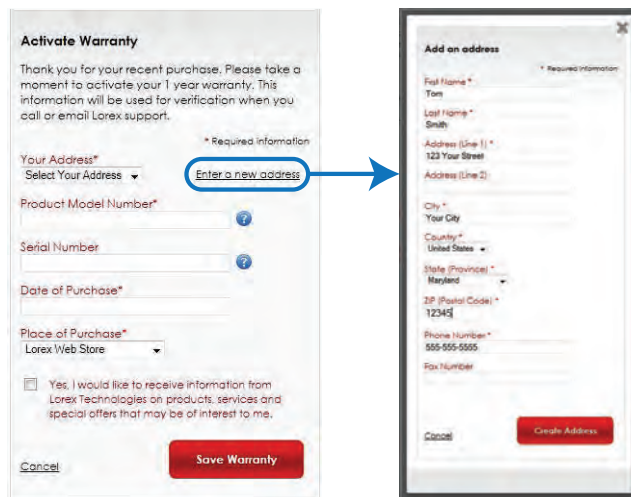

- Fill in the warranty registration form with your product and purchase details. Check the sticker underneath your system for the Product Model Number and Serial Number. You can also upload a scan, photo, or electronic copy of your receipt or bill of sale. Click **Save Warranty**.

Activate Warranty

Thank you for your recent purchase. Please take a moment to activate your 1 year warranty. This information will be used for verification when you call or email Lorex support.

* Required information

Your Address*

Product Model Number*

Serial Number

Date of Purchase*

Place of Purchase*

Bill of Sale
 Select an image file on your computer.
 Supported formats: jpg, png, pdf, Max file size: 5MB

Yes, I would like to receive information from Lorex Technologies on products, services and special offers that may be of interest to me.

- A page pops up to prompt you to register your product for Lorex DDNS. Click **Set Up a New DDNS**.



- Configure the following:

- 8.1. **Product Warranty:** Select the product warranty you created in the previous steps.
- 8.2. **Device Name:** Enter a name for your device. You can enter your name, business name, or anything of your choice. This is used to identify this device in your list of activated DDNS accounts that appears anytime you visit the DDNS page.
- 8.3. **MAC Address:** Enter the MAC address of your Lorex product. To find the MAC address:
 - Right-click to open the Quick Menu and click **Info**. Enter the system user name (default: **admin**) and password (default: **000000**).



- 8.4. **URL Request:** Enter the web site address that will be used to connect to your Lorex product. For example, if you enter *tomsmith*, the address to access your video will be *http://www.tomsmith.lorexddns.net*.
9. Click **Save** to register your product for DDNS. A confirmation email will be sent to the email address used to register for My Lorex. **You will need this information to enable remote access to your system.** Record your information below:

| | |
|--------------------------|--|
| Domain name/URL Request: | |
| DDNS User Name: | |
| Device DDNS password: | |

17.2.3 Step 3 of 4: Enable DDNS on the System

To enable DDNS in your System:

1. Right-click and click **Main Menu**. Enter the system password if prompted.
2. Click  and then click **Network>DDNS**.

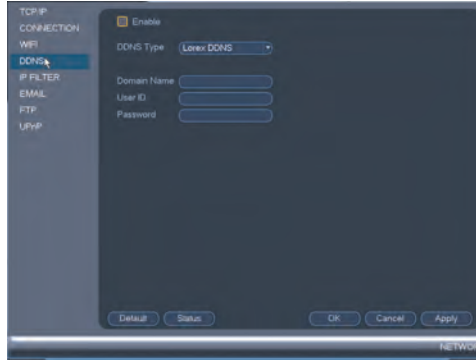

3. Check **Enable**.
4. Under **Domain Name**, enter the Domain Name/URL Request you received in the email after registering for DDNS.
5. Under **User Name**, enter your DDNS User Name.
6. Under **Password**, enter your DDNS Device password.
7. Click **OK** to save your settings.



NOTE

Please allow 10~15 minutes for the DDNS servers to update with your new DDNS address before attempting to connect.

17.2.4 Step 4 of 4: Connect to the System's DDNS Address



NOTE

Please allow 10~15 minutes for the DDNS servers to update with your new DDNS address before attempting to connect.

To connect using the system's DDNS address:

1. Download and install the client software on a remote computer.
 - **PC Users:** Download and install the **Client Software for PC** from www.lorextechnology.com/support.
 - **Mac Users:** Download and install the **Client Software for Mac** from www.lorextechnology.com/support. Double click to extract the software. Drag the software to **Applications**.
2. Once installation is finished, double-click the FLIR Cloud™ Client icon () from the desktop.

- Log into the Client Software using the Client Software user name (default: **admin**) and password (default: **admin**) and then click **Login**.

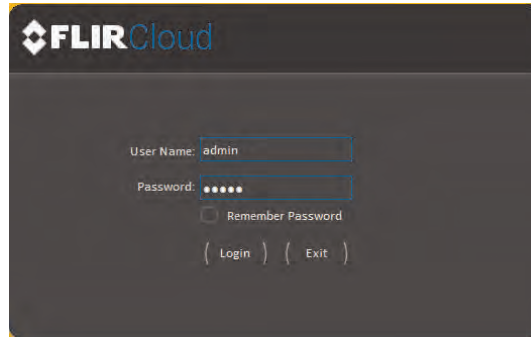

- Click **Add Device**.

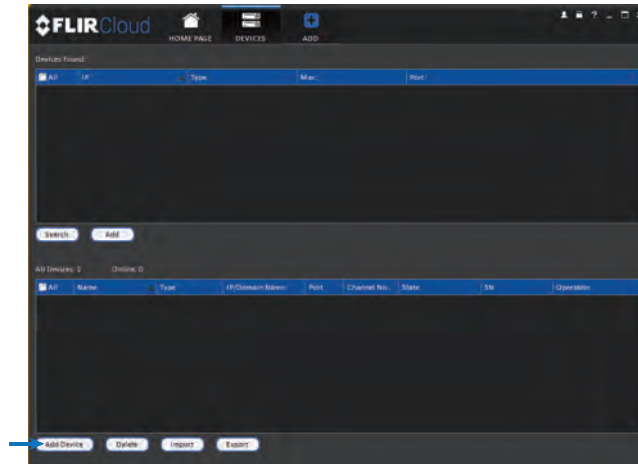

- Enter the following:

The screenshot shows the 'Add Device' dialog box with the following fields and values:

- Device Name: HD System
- Group Name: Default Group
- Type: DVR
- IP/DDNS Address: tosmith.lorexddns.net
- Port: 35000
- User Name: admin
- Password: [masked]

Buttons: Retrieve Info, Add More, Add, Cancel

- 5.1. Check **By IP/Domain** to add a system using the DDNS address.
- 5.2. **Device Name:** Choose a name for your system of your choice.
- 5.3. **IP/DDNS Address:** Enter the Domain Name/URL Request you received in the email when you registered for DDNS followed by **.lorexddns.net**.

**NOTE**

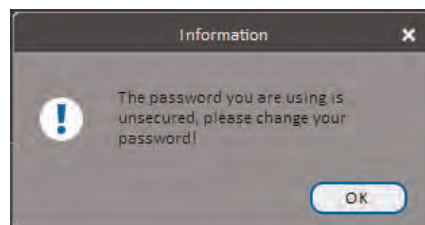

For example, if your Domain Name/URL Request is tosmith, enter *tomsmith.lorexddns.net*

- 5.4. **Client Port:** Enter the Client Port (default: **35000**).
 - 5.5. **User Name:** Enter the system User Name (default: **admin**).
 - 5.6. **Password:** Enter the system Password (default: **000000**).
6. Click **Add**. If this is the first time you are connecting, you will be prompted to change the system password.

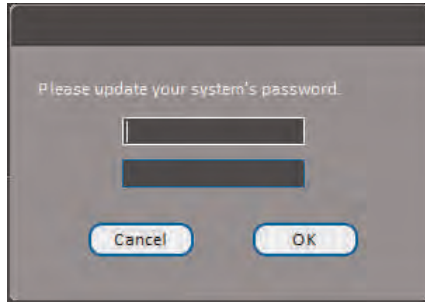

7. Enter a new 6 character password and click **OK**. This password will be used to connect to your system from now on.



8. Click  then .
9. Click and drag **Default Group** to the display window to open your cameras in live view.

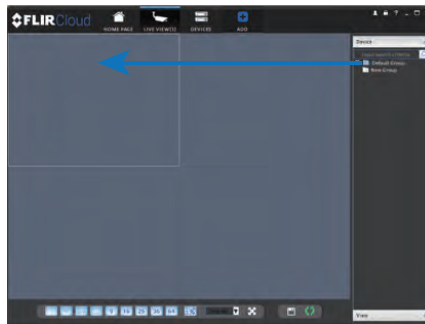

Congratulations! You can now connect over the Internet to view and playback video on your computer.



Connecting a PTZ Camera (LNR110 Series)

You can connect PTZ cameras (not included) to the system. You must use Lorex IP PTZ cameras with the system. Lorex IP PTZ cameras can accept PTZ commands directly through the Ethernet cable. There is no need to run special wiring to use PTZ cameras.

NOTE

For a list of compatible cameras, please visit www.lorextechnology.com/support.

18.1 Controlling a PTZ Camera (Local NVR)

1. In Live View, double-click the channel that has the PTZ camera connected to open in full-screen.
2. Right-click and click **PTZ**. Enter the system user name and password if prompted. The PTZ menu opens.
3. Use the on-screen PTZ controls to control the camera.

PTZ Controls

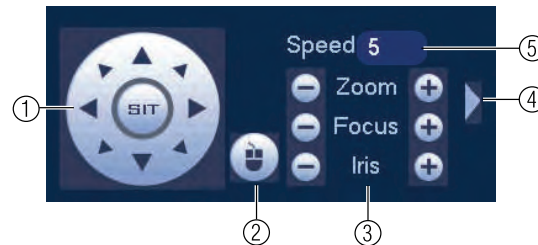

1. **Direction keys:** Click to pan and tilt the camera. Click **SIT** to stop the current action.
2. **Mouse PTZ:** Click to activate mouse PTZ mode. In mouse PTZ mode:
 - Click and drag to move the camera.
 - Use the scroll wheel to zoom in and out.
 - Right-click to exit and return to normal PTZ controls.
3. **Zoom/Focus/Iris:** Click +/- to adjust the zoom, focus, and iris.
4. **Advanced controls:** Click to open advanced PTZ controls.
5. **Speed:** Enter the PTZ speed.

18.2 Advanced PTZ Controls

Advanced PTZ controls can be used to save camera positions and cycle through various positions, and automate camera actions.

To open advanced PTZ controls:

- Click the arrow in the PTZ control window to open advanced controls.

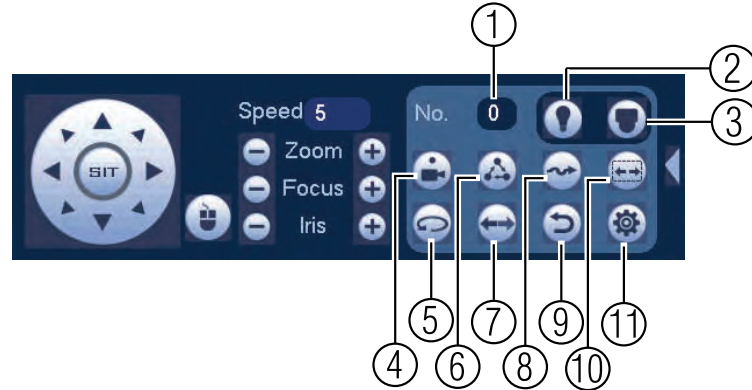

Advanced PTZ controls overview:

1. **No.:** Select the number of the action you want to perform.
2. **Not supported.**
3. **PTZ camera menu:** Click to open the camera's OSD menu. This may not be supported on all camera models.
4. **Preset:** Click to call the selected preset.
5. **Autopan:** Click to start autopan. During autopan, the camera will continuously pan 360°.
6. **Tour:** Click to run the selected tour.
7. **Flip:** Click to flip the camera 180°.
8. **Reset:** Click to move the camera to the home position.
9. **Pattern:** Click to run the selected pattern.
10. **Auto scan:** Click to run the selected autoscan.
11. **Aux:** Click to open the aux menu, where you can set up Presets, Tours, Patterns, and Auto Scans.

18.2.1 Presets

Presets will save a camera position for quick retrieval.

To add presets:

1. Click  to open the aux menu.
2. Click the **Preset** tab.



3. Enter the number of the preset you want to create under **Preset**.
4. Move the camera to the desired position and click **Set**.

To go to a preset:

- Under **No.**, select the number of the preset you would like to go to and click .

18.2.2 Tours

Tours will cycle through a set of presets.

To create a tour:

1. Click  to open the aux menu.
2. Click the **Tour** tab.



3. Under **Patrol No.**, select the tour you would like to configure.
4. Under **Preset**, select a preset you would like to add to the tour.
5. Click **Add Preset**.
6. Repeat steps 4 and 5 to add additional presets to the tour.

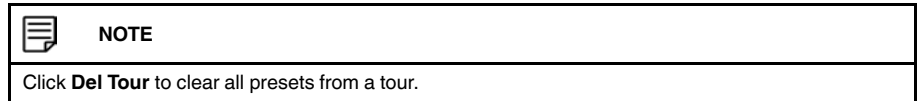

To run a tour:

- Under **No.**, select the number of the tour you would like to go to and click .

18.2.3 Pattern

Patterns automatically cycle the camera between two positions.

To create a pattern:

1. Click  to open the aux menu.
2. Click the **Pattern** tab.



3. Under **Pattern**, enter the pattern you would like to configure.
4. Move the camera into the desired start position and click **Begin**.
5. Move the camera into the desired end position and click **End**.

To run a pattern:

-
- Under **No.**, select the number of the pattern you would like to go to and click .

18.2.4 Auto Scan

An auto scan automatically cycles between a left and right point.

To create a new auto scan:

1. Click  to open the aux menu.
2. Click the **Border** tab.



3. Move the camera into the desired left position and click **Left**.
4. Move the camera into the desired right position and click **Right**.

To run an auto scan:

- Click .

LNR110 Series Hard Drive Installation

The system comes with a pre-installed 3.5" SATA hard drive. You can replace the hard drive with one up to a maximum size of 4TB.



NOTE

It is recommended to use surveillance or security-certified hard drives, which are designed to be reliable over long periods of time while recording 24/7. Security-certified hard drives are available at www.lorextechnology.com.

19.1 Installing a Hard Drive



CAUTION

Make sure that the system is OFF and ALL power adapters have been disconnected before removing/installing the hard drive.

To install the hard drive:

1. Insert hard drive screws (4x) on the hard drive and tighten them half way.

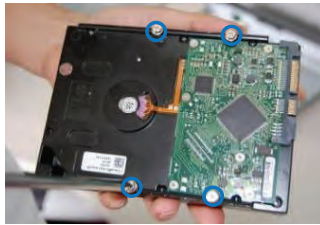

2. Power off the system, and unplug all cabling from the system.
3. Turn the NVR over and remove the cover screws (6x).

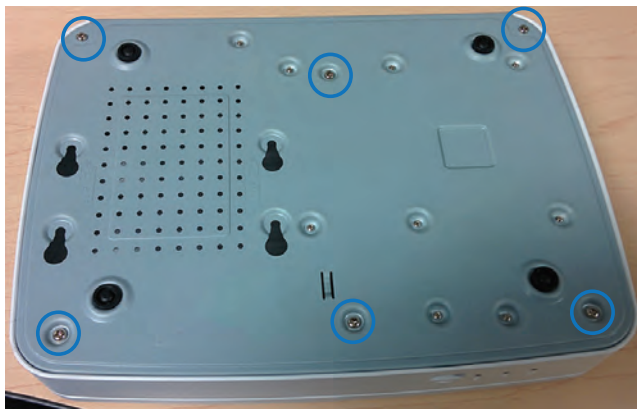

-
4. Turn the NVR back over and remove the cover. The easiest way to do this is to pull up on the edge that hangs over the rear panel of the unit.

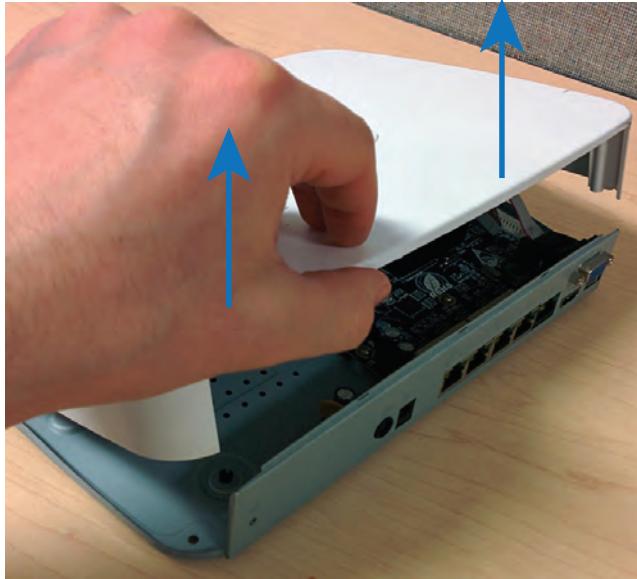

5. Place the hard drive over the screw slots on the bottom of the NVR and then slide the hard drive into place. The SATA connectors on the hard drive should face the front of the unit.



6. Connect the SATA power and data cable to the hard drive.



- Turn the NVR over carefully. Tighten the hard drive screws (4x) to secure the hard drive.

**CAUTION**

Hold the hard drive in place when turning the NVR over to prevent damage to the NVR.

- Replace the cover and cover screws (6x).

**NOTE**

After installation, you must format the hard drive in order to use it with the system. See 13.3.17 *Formatting the Hard Drive*, page 67.

19.2 Removing the Hard Drive

**CAUTION**

Make sure that the system is OFF and ALL power adapters have been disconnected before removing/installing the hard drive.

- Power off the system, and unplug all cabling from the system.
- Turn the NVR over and remove the cover screws (6x).

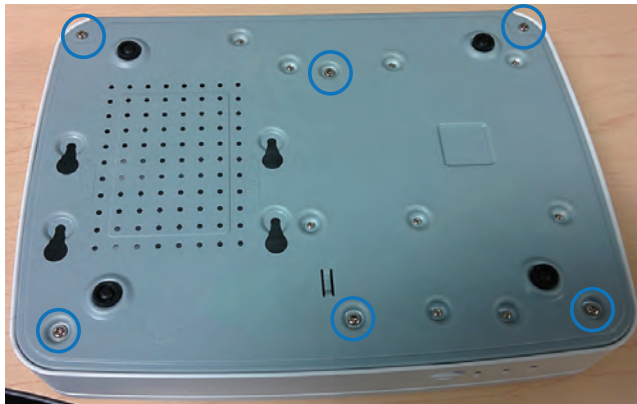

3. Loosen the hard drive screws (4x), but do not remove them.



4. Carefully turn the NVR over and remove the cover. The easiest way to do this is to pull up on the edge that hangs over the rear panel of the unit.

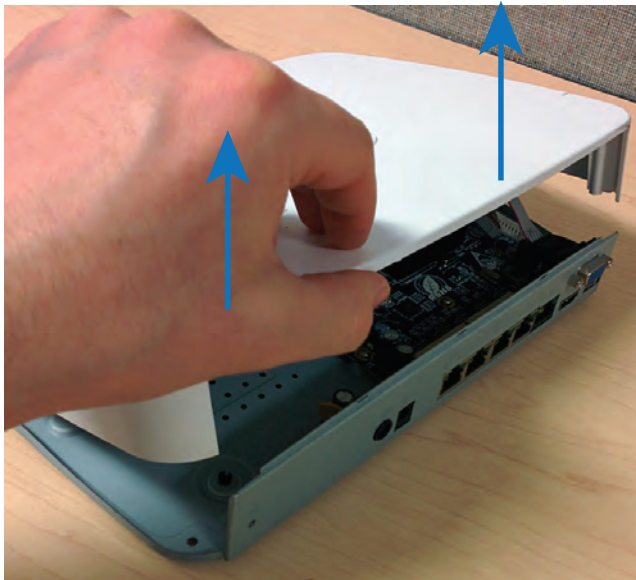

5. Disconnect the SATA power and data cable from the hard drive.



6. Slide the hard drive towards the front of the NVR and remove it from the unit.

7. Replace the cover and cover screws (6x).

**NOTE**

After installation, you must format the hard drive in order to use it with the system. See 13.3.17 *Formatting the Hard Drive*, page 67.

19.3 Formatting Hard Drives

You must format hard drives before you may use them with the system.

**CAUTION**

Formatting the HDD erases all data on the hard disk. This step cannot be undone. System settings will not be erased.

To format the hard drive:

1. From the Main Menu, click  and then click **Storage>HDD Manager**.

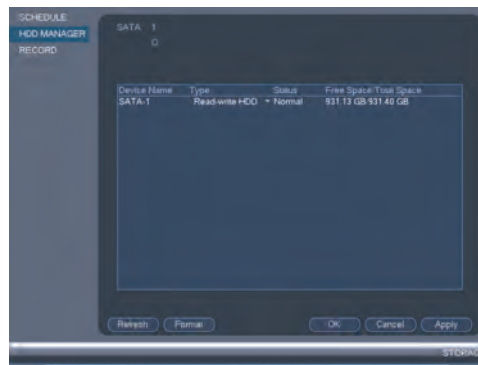

2. Select the hard drive you would like to format and then click **Format**. Click **OK** to confirm.
3. Click **OK** to save changes. The system will restart to complete the formatting process.

The system can record audio on any channels that have audio-capable cameras connected to them. You must have an audio-capable camera (not included) in order to record audio using the system. The camera must have a built-in microphone or an audio input cable (for example RCA) for connecting a self-powered microphone.

**NOTE**

The MIC IN/OUT ports on the rear panel of the system are not supported and cannot be used for audio recording.

Audio recording without consent is illegal in certain jurisdictions. Lorex Technology Inc. assumes no liability for use of its products that does not confirm with local laws.

20.1 Step 1 of 2: Connecting an audio-capable camera

Connect the camera to the NVR or network. If the camera is connected to the network, add it to the NVR. For details, see 6.11 *Connecting Cameras to the Local Area Network (LAN)*, page 13.

Option A: Connect a camera with a built-in microphone.

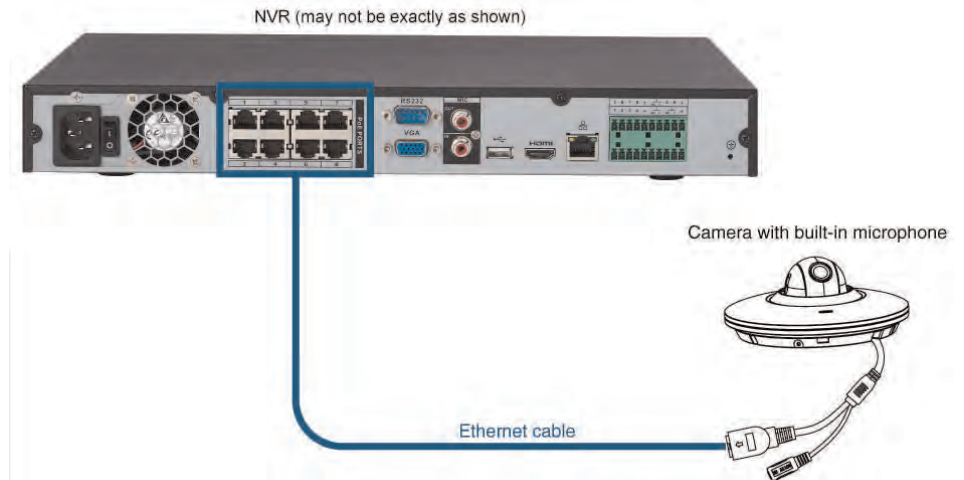

Option B: Connect a camera with audio input.

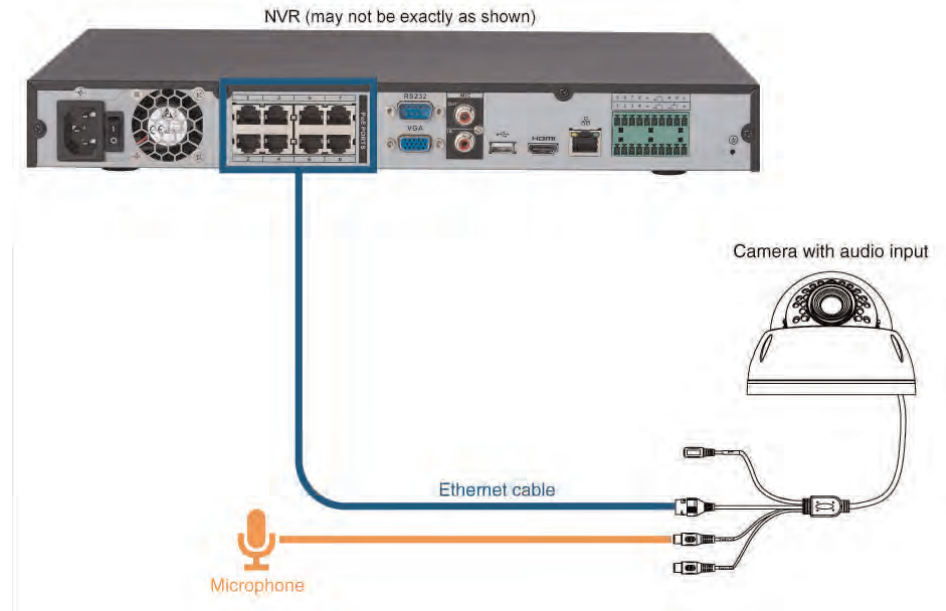

NOTE

The microphone must have its own power source.

20.2 Step 2 of 2: Configuring audio recording

1. Right-click and click **Main Menu**. Enter the system user name (default: **admin**) and password (default: **000000**) if prompted.
2. Click  and select **Recording>Recording**.

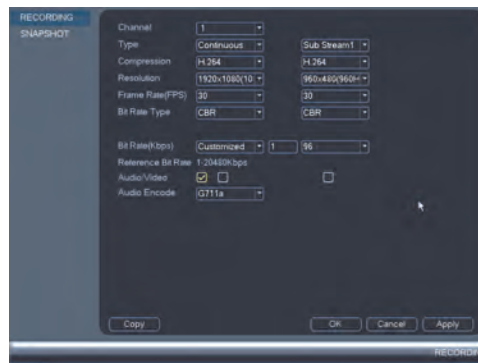

3. Under **Channel**, select the channel where the audio-capable camera is connected.
4. Under **Audio/Video**, check the box on the left to enable audio recording.
5. Under **Audio Encode**, select the format that will be used to record audio. **G711a** is recommended.
6. Click **OK** to save changes.

When a malfunction occurs, it may not be serious and can be corrected easily. The following describes the most common problems and solutions. Please refer to the following before calling Lorex Technical Support:

| Error | Possible Causes | Solutions |
|---|--|---|
| <ul style="list-style-type: none"> NVR is not receiving power, or is not powering up. | <ul style="list-style-type: none"> Cable from power adapter is loose or is unplugged. | <ul style="list-style-type: none"> Confirm that all cables are connected correctly. Confirm that the power adapter is securely connected to the back of the unit. |
| | <ul style="list-style-type: none"> Cables are connected, but NVR is not receiving sufficient power. | <ul style="list-style-type: none"> Confirm that the unit is powered on (LED indicators on the front should be ON). If the unit is connected through a power bar or surge protector, try bypassing the bar and connecting the power directly to the wall outlet. Confirm that there is power at the outlet: <ul style="list-style-type: none"> Connect the power cable to another outlet. Test the outlet with another plugged device (such as an electric calculator or phone charger). |
| <ul style="list-style-type: none"> There is no picture on selected channels / camera picture is not being displayed. | <ul style="list-style-type: none"> Camera cables are loose or have become disconnected. | <ul style="list-style-type: none"> Disconnect and reconnect the cable at the NVR and at the camera. Try moving the camera to another channel or use another cable. If your cameras are not using PoE, make sure they are using the correct power source according to the specifications. |
| | <ul style="list-style-type: none"> Camera/NVR connection to LAN has become interrupted. | <ul style="list-style-type: none"> Make sure your cameras are connected to the same LAN as the NVR. Make sure any routers or switches in between the NVR and IP cameras are powered on. |
| <ul style="list-style-type: none"> Hard drive is not detected by the system. | <ul style="list-style-type: none"> Hard drive cables are loose or not properly connected. | <ul style="list-style-type: none"> Remove the housing and check that hard drive cables are firmly connected. |
| | <ul style="list-style-type: none"> Hard drive has not been initialized (formatted) by the system. | <ul style="list-style-type: none"> For details, see 13.3.17 <i>Formatting the Hard Drive</i>, page 67. |
| | <ul style="list-style-type: none"> There is no hard drive in the system. | <ul style="list-style-type: none"> Open the housing and install a 3.5" SATA hard drive. |
| <ul style="list-style-type: none"> Hard drive is full and the unit is no longer recording. | <ul style="list-style-type: none"> Overwrite is not enabled. | <ul style="list-style-type: none"> From the Main Menu, select General. Beside HDD Full, select Overwrite. Click OK to save settings. This enables the system to continuously record by overwriting data once the hard drive is full. |

| Error | Possible Causes | Solutions |
|--|--|---|
| <ul style="list-style-type: none"> Mouse not detected by system. | <ul style="list-style-type: none"> Mouse cable is not firmly connected to the system. | <ul style="list-style-type: none"> Firmly connect the mouse cable to the system. |
| | <ul style="list-style-type: none"> Mouse is not connected to the system. | |
| | <ul style="list-style-type: none"> System needs to be reset. | <ul style="list-style-type: none"> Re-connect the power cord to restart the system. |
| <ul style="list-style-type: none"> My system does not seem to be recording. | <ul style="list-style-type: none"> Recording may be disabled. | <ul style="list-style-type: none"> Right-click in live view, and click Record. Ensure that each channel is set to Schedule or Manual. If schedule is selected, make sure schedule settings are correct under Schedule. ATTENTION: For security, it is highly recommended to keep Continuous Recording ON at all times. |
| <ul style="list-style-type: none"> The system beeps at startup. | <ul style="list-style-type: none"> The beep at startup is normal. | |
| <ul style="list-style-type: none"> I am not receiving email notifications. | <ul style="list-style-type: none"> Email notification is disabled. | <ul style="list-style-type: none"> Ensure you have configured email notification. See 13.3.5 <i>Configuring Email Alerts</i>, page 56 for details. |
| | <ul style="list-style-type: none"> Default setting is disabled, but you have not entered your own SMTP information. | <ul style="list-style-type: none"> If you want to use your own SMTP server, deselect the Default box, and enter your SMTP Server address, Port, User name, and Password in the respective fields. |
| | <ul style="list-style-type: none"> Send Email setting not enabled in Motion menu. | <ul style="list-style-type: none"> Make sure that Send Email is checked for cameras you wish to receive email notifications from. See 13.3.8 <i>Configuring Motion Detection</i>, page 59 for details. |

LNR110 Series System Specifications

22.1 System

| | |
|--------------------|--|
| Operating System | Embedded LINUX |
| Pentaplex | Simultaneous View, Record, Playback, Backup, and Remote Monitoring |
| Number of Channels | 4/8 Channels |

22.2 Inputs/Outputs

| | |
|-------------------------|---|
| Video IN | 4/8 ch: PoE Video Input |
| Video OUT | Yes, 1 VGA & 1 HDMI |
| VGA OUT | Yes |
| HDMI | Yes |
| Audio IN | 1 Line IN (RCA) for two-way audio |
| Audio OUT | 1 Line OUT (RCA) for two-way audio |
| USB Port | 1 at the back, 1 at the front |
| Alarm IN | No |
| Alarm OUT | No |
| Video Output Resolution | 1920x1080, 1280x1024, 1280x720, 1024x768, 800x600 |
| PTZ Control | Loxex IP PTZ cameras only |

22.3 Display

| | |
|----------------------|---|
| Display Split | 4 ch: 1/4 8 ch: 1/4/8/9 |
| Live Display Speed | 4 ch: 120 NTSC, 100 PAL 8 ch: 240 NTSC, 200 PAL |
| OSD | Camera Title, Time, Camera Lock, Motion Detection, Recording Status |
| System Navigation | USB mouse |
| Motion Area Setting | Adjustable grid (22x18) |
| Sensitivity Levels | 100 |
| Firmware Upgrade | Automatic over the Internet & via USB device and network |
| User Authority | By user group |
| Time Synchronization | Auto time sync by NTP server |

22.4 Recording

| | |
|------------------------------|---|
| Compression | H.264 |
| Resolution | 1080P (1920x1080) / 720P (1280x720) |
| Record Rate | 120FPS @ 1080P / 240FPS @ 720P |
| Recording Resolution Setting | Per camera for different resolutions |
| Recording Quality Control | 6 levels |
| Record Schedule | By hour, by day, by recording mode, by motion, by channel |

| | |
|----------------|--|
| Pre Recording | Max. 30 Seconds |
| Post Recording | Max. 5 Minutes |
| Reliability | Watch-Dog, auto-recovery after power failure |
| Covert Video | Yes |

22.5 Playback and Backup

| | |
|------------------|---|
| Playback Channel | 4 ch: 1/4 8 ch: 1/4/8 |
| Playback Speed | Variable Max 16x |
| Playback Players | Backup Player |
| Search | By time & event |
| Log Search | Up to 1,000 lines for motion detected, configuration changes, connects/disconnects and video loss |
| Audio Play | Yes (audio camera required) |

22.6 Storage & Archive

| | |
|--------------------|-------------------------------------|
| Storage | 4/8 ch: Up to 1 HDD's (SATA) |
| Maximum Capacity | 4/8 ch: Up to 1x4TB |
| Backup Media | USB flash drive & HDD |
| Backup File Format | DAV or ASF file |

22.7 Connectivity

| | |
|--------------------------------------|---|
| Cloud Connection | FLIR Cloud™ |
| Supported Operating Systems | Windows™ Mac OSX |
| Remote Software | Client Software (PC/Mac) |
| Email Notification | Text with snapshot |
| Instant Smart Phone & Tablet Support | iPad®, iPhone®, Android™ |
| DDNS | Free Lorex DDNS |
| System Configuration | Full setup configuration over network |
| Ports | Programmable by user |
| Network Protocol | HTTP, IPv4/IPv6, TCP/IP, UPNP, RTSP, UDP, SMTP, NTP, DHCP, DNS, PPPOE, DDNS, FTP, IP Filter |
| Network Interface | 10/100-Base-TX, RJ-45 |
| Network Bit Rate | 80Mbps total 48~8192kbps per camera |

22.8 General

| | |
|-------------------|--|
| Power Consumption | Approx. 12 watts (No HDD Installed) |
| Supply Voltage | 4 ch: 100VAC-240VAC, 48V DC, 1.5A, 50/60Hz 8 ch: 100VAC-240VAC, 48V DC, 2A, 50/60Hz |
| Unit Weight | 0.7kg / 1.5lbs (without HDD) |

| | |
|------------------------|--|
| Dimensions (W x H x D) | 270mm x 205mm x 45mm / 10.6" x 8.1" x 1.8" |
| Operating Temperature | 14° ~ 131° F / -10° ~ 55° C |
| Humidity | 10 ~ 90% RH |

22.9 Recording Resolution (Pixels) & Speed (FPS — Frames per second)

| Model | FPS | 720P | 1080P |
|-------|-------------|----------|-----------|
| | | 1280x720 | 1920x1080 |
| 4ch | Total | 120 | 120 |
| | Per channel | 30 | 30 |
| 8ch | Total | 240 | 120 |
| | Per channel | 30 | 15 |

As our products are subject to continuous improvement, Lorex Corporation and its subsidiaries reserve the right to modify product design, specifications, and prices without notice and without incurring any obligation. E&OE

This product has been certified and found to comply with the limits regulated by FCC, EMC, and LVD. Therefore, it is designated to provide reasonable protection against interference and will not cause interference with other appliance usage. However, it is imperative that the user follows the guidelines in this manual to avoid improper usage, which may result in damage to the product, electrical shock and fire hazard injury.

23.1 FCC/IC Notice

This equipment has been tested and found to comply with the limits for a Class B digital device, pursuant to Part 15 of the FCC Rules. These limits are designed to provide reasonable protection against harmful interference in a residential installation. This equipment generates, uses, and can radiate radio frequency energy and, if not installed and used in accordance with the instruction, may cause harmful interference to radio communications.

However, there is no guarantee that interference will not occur in a particular installation. If this equipment does cause harmful interference to radio or television reception (which can be determined by turning the equipment on and off), the user is encouraged to try to correct the interference by one or more of the following measures:

1. Reorient or relocate the receiving antenna.
2. Increase the separation between the equipment and receiver.
3. Connect the equipment into an outlet on a circuit different from that to which the receiver is connected.
4. Consult the dealer or an experienced radio or television technician for assistance.

23.2 Modification

Any changes or modifications not expressly approved by the grantee of this device could void the user's authority to operate the device.

Toute modification non approuvée explicitement par le fournisseur de licence de l'appareil peut entraîner l'annulation du droit de l'utilisateur à utiliser l'appareil.

23.3 ROHS

This product is fully compliant with the European Union Restriction of the Use of Certain Hazardous Substances in Electrical and Electronic Equipment ("RoHS") Directive (2002/95/EC). The RoHS directive prohibits the sale of electronic equipment containing certain hazardous substances such as lead, cadmium, mercury, and hexavalent chromium, PBB, and PBDE in the European Union.



Website

www.lorextechnology.com

Copyright

© 2015, Lorex Corporation

All rights reserved worldwide. Names and marks appearing herein are either registered trademarks or trademarks of Lorex Corporation and/or its subsidiaries. All other trademarks, trade names or company names referenced herein are used for identification only and are the property of their respective owners.

Legal disclaimer

As our product is subject to continuous improvement, Lorex Corporation & subsidiaries reserve the right to modify product design, specifications & prices without notice and without incurring any obligation. E&OE.

Publ. No.: LX400070
Release: 1.0
Commit: 27147
Head: 27147
Language: en-US
Modified: 2015-06-23
Formatted: 2015-06-23